



Cardiff County Council

ST DAVID'S HALL - RAAC ROOF PLANK SURVEY



WSP



Cardiff County Council

ST DAVID'S HALL - RAAC ROOF PLANK SURVEY

TYPE OF DOCUMENT (VERSION) PUBLIC

PROJECT NO. 70086249

OUR REF. NO. WSP-XX-XX-RP-S-000001

DATE: OCTOBER 2023

WSP

1 Capital Quarter

Tyndall Street

Cardiff

CF10 4BZ

Phone: +44 2920 769 200

WSP.com



QUALITY CONTROL

Issue/revision		First issue			
Remarks					
Date		October 2023			
Prepared by		Helen Phillips/ Stuart Renshaw			
Signature					
Checked by		Chris Pembridge			
Signature					
Authorised by		Matthew Palmer			
Signature					
Project number		70086249			
Report number		WSP-XX-XX-RP-S-000001			
File reference					



CONTENTS

	EXECUTIVE SUMMARY	2
1	INTRODUCTION	3
2	RAAC OVERVIEW	4
3	RAPPEL SURVEY DATA	6
4	SURVEY SUMMARY	12
5	REMEDIAL OPTIONS	13
6	CONCLUSION	14

APPENDICES

APPENDIX A

RAPPEL SURVEY DATA - END BEARING MEASUREMENTS

APPENDIX B

RAPPEL SURVEY DATA – INTRUSIVE SITE INVESTIGATIONS

EXECUTIVE SUMMARY

WSP originally prepared an assessment report on the condition of the RAAC Panels in the roof of St David's Hall in 2021. This initial inspection of the RAAC Panels presented a technical risk profile as regards failure and made recommendations for ongoing assessment and remedial measures. An important element to note in that report was around the inability to investigate the end supports of the RAAC Panels due to the access available.

This report was prepared based on BRE and the IStructE published guidance at that time.

In April 2023, IStructE published new guidance for the Assessment of RAAC panels. It is this new guidance that has likely changed the positioning around assessment of RAAC Panels and the HSE Statements / Guidance, etc.

The greatest change in the new guidance is that it requires more stringent and indeed intrusive investigation of the end bearing condition.

The fact that this end bearing was unable to be investigated on this project has meant that the conclusions of the original 2021 report would now fall outside current guidance, albeit that the risks presented were based on an inability to inspect the end bearing condition.

The 6 monthly assessments as recommended in our original report have been undertaken and no significant deterioration in the condition of the RAAC panels has occurred.

The new April 2023 guidance required Intrusive Investigation into the end bearing condition of the panels. This is because hidden failures has been identified due to the end condition. An example of such a 'hidden' failure is shown in the image below:

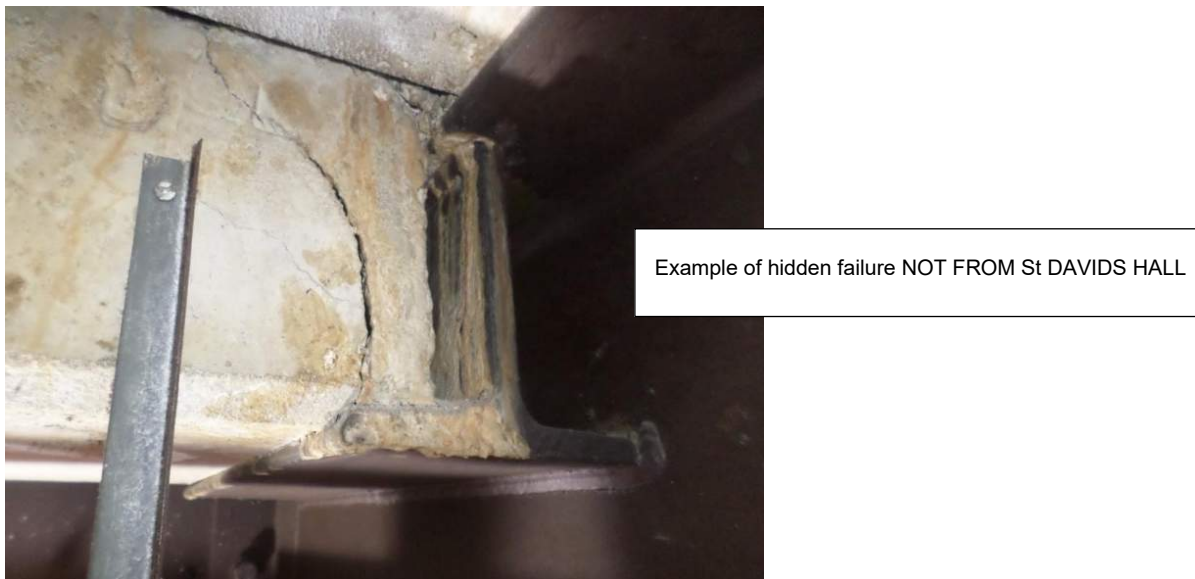

This Report presents the results of this Intrusive Investigation.

Two aspects have been investigated:

- The length of bearing present
- The presence of longitudinal and transverse reinforcement over the bearing.

The results of the investigation presented herein are summarised as follows based on interpolation of the number of investigation points over the whole number of RAAC Panels:

Red – End bearing checks undertaken by Rappel highlight a large majority of bearings <75mm, with the average bearing length found to be 62mm. Approximately 279 No. readings were found to be between 45mm ≤ X <75mm, which equates to 66% of readings taken.

Red (critical) – As identified on the intrusive surveys, 1 out of the 10 survey points were found to lack required transverse reinforcement, equating to 10%. Extrapolating this value, we would therefore anticipate 93 No. panels to not have a transverse bar over the support over the entirety of the site.

Red (critical) – 49 No. end bearing measurements were found to be <45mm, which equates to 12% of readings taken. Due to these being below the original design criteria (45mm), they are to be classified as red (critical).

It can be Interpolated that:

- 10% or 93 No of the panels will not have transverse reinforcement present over the bearing length making 10% of the panels RED – CRITICAL RISK on this point.
- The maximum bearing length encountered was 62mm which is less than the 75mm guidance making the average condition RED - HIGH RISK
- End bearing checks identified 279 No readings between 45mm and 62mm – RED – HIGH RISK
- Longitudinal reinforcement was found to be present in all test locations.
- 49 No End bearing measurements were found to be less than 45mm (the original design criteria), this is approximately 12% - RED – CRITICAL RISK

Therefore, the overall risk category for the roof is **RED – CRITICAL RISK**.

The IStructE Guidance therefore requires, urgent remedial works. This may include taking out of use or temporary propping to allow safe ongoing use of the building. The consideration of this needs to be assessed through Health Safety & Operational risk assessment. This will need to take into account insurers, promoters and other user groups.

This report has identified a form of urgent remedial measures. This would entail significant access to the roof areas either through roped access or scaffolding.

Given the guidance and condition of the planks and particularly the lack of original design end bearing replacement of the planks should be considered as a requirement subject to replacement.

In considering structural components to replace the RAAC panels, consideration needs to be given to the self-weight / dead loading of the replaced element and the acoustic performance of the theatre space in terms of mass and surface hardness.

NEXT STEP

The duty holder of the building should next undertake a risk assessment of the building considering the risks identified in this report, the use of the building and the published guidance from the HSE.

In addition, we are aware that the presence of RAAC Panels can affect the insurances available to operate buildings. This should be considered by the building owner and operator.

1 INTRODUCTION

As a result of recent changes to the advice on RAAC Panels in public buildings, issued by the Health and Safety Executive, Cardiff Council has instructed WSP to undertake further exploratory works to explore the condition of the RAAC panels at St David's Hall and mitigate any further risk in all instances of RAAC construction. During September to October 2023, intrusive investigation has been undertaken by Rappel (a rope access contractor) to identify the reinforcement and bearing length of the panels in accordance with the latest Institution of Structural Engineer's guidance documents.

This report aims to provide a description of the survey process undertaken, a summary of the intrusive investigation findings and a description of possible remedial options which should be considered to ensure safety of the building. The report will identify the risks presented by the presence of the RAAC Panels, their condition and characteristics identified during this Intrusive Investigation. This risk categorisation will allow the building duty holder to undertake a risk assessment on the next actions necessary to ensure the safety in operation of the building.

Please note: Rappel had previously undertaken a visual survey of the roof space, focused on the perimeter, where they found approximately 100+ defects such cracks to the ends of the panels as well as previous builders works holes, etc. This investigation was carried out on behalf of Live Nation by Buro Happold as part of their pre-acquisition surveys. The findings in this WSP report are independent of Live Nation surveys.

2 RAAC OVERVIEW

The following section provides an overview of the historic use of RAAC panels, its structural properties, potential defects, and previous investigations that have been undertaken,

2.1 MATERIALS, PROPERTIES AND CHARACTERISTICS

RAAC planks are believed to have first been used in 1929 and are understood to have been used in the UK since the late 1950s. They were widely used for roofing but also for walls, partitions, and floors until 1982 when production in the UK ceased, reportedly for commercial reasons.

The planks were made from a raw slurry comprising lime and cement mixed with fine grained sand and combined with admixtures. Air or gas was then introduced into the slurry, and the resulting foam-like liquid poured into a mould and allowed to take on an initial set, after which the large block was cut to size and steam cured under high temperature and pressure. Individual planks were then cut from the large block.

The resulting planks are of relatively low density, variable between 300-1,000kg/m³, but more typically 400-700 kg/m³.

Figure 1 - Images showing physical properties of RAAC panels



The planks contain embedded steel to improve the flexural and shear capacities, which are low in unreinforced AAC blocks. The reinforcement is typically light gauge steel wire but in later examples reinforcement bar is used.

Unlike normal high-density reinforced concrete there is no appreciable bond between the steel and the AAC: transfer of flexural tension is achieved by transverse steel near the end of the planks. The transverse steel is welded to the longitudinal tension steel to aid transfer of forces into the AAC.

The automatic protection offered to embedded steel in normal reinforced concrete is absent in RAAC, therefore the steel is chemically coated to prevent corrosion.

2.2 HISTORIC RAAC DEFECTS AND PREVIOUS INVESTIGATIONS

In the early 1990's general concerns were raised over the structural adequacy of RAAC planks by some structural engineers and some national/local government bodies, particularly regarding planks made before

1980. These concerns were based on reports of cracking to the soffit of panels, excessive deflection, rusting of embedded reinforcement leading to cracking/spalling, and lack/loss of diaphragm action of roof plates made from RAAC panels. The 'typical' cracking exhibited by planks showing a sign of distress recorded by BRE was a pattern of roughly parallel fine/hairline transverse cracking at fairly regular intervals along the span – see figure 1.

The Building Research Establishment (BRE) were asked to advise on reported defects where the long-term deflections of flat roofs built from RAAC planks had caused serviceability issues such as water ponding and consequent increase in load from retained water, distress to applied membranes leading to water ingress and corrosion of embedded reinforcement. However, BRE recognised that there was no objective guidance on the structural capacity of deflected/cracked planks, their safety, or their likely long-term performance. As a consequence of this recognition BRE devised a series of tests commencing in 1991.

The 1991 tests were on panels removed from a housing development after some 20 years' service and which showed extensive hairline cracking to the soffits. In summary, these tests convinced BRE that although visibly deflected and cracked the panels when loaded to failure gave adequate warning of imminent failure via "local crushing, horizontal delamination and extensive cracking of the AAC panel in the vicinity of the supports". The tests noted that the deflections at ultimate load (i.e., the load at which failure occurred) were in excess of 1/50th of the span. BRE also reported that for the tested planks there was no deficiency in the AAC matrix, and that corrosion of embedded steel had not led to appreciable losses of steel section.

A second set of 1995 tests were carried out on new panels made in Europe. BRE noted that some panels lacked the transverse reinforcement at the ends necessary for load transfer from the longitudinal steel, and that as a consequence failure occurred at the ends of such defective planks. BRE concluded that correctly manufactured planks i.e., those with transverse reinforcement at the ends – were likely to give warning of collapse by cracking and spalling of the AAC, and that failure would be ductile giving ample warning of failure via appreciable deflection prior to collapse. It should be noted that BRE found that the average span to deflection ratio at failure was about 71, the range being 50-93.

A further point to note from the second 1995 tests is BRE's observation that creep deflection is not proportionally related to elastic deflection. This means that whereas instantaneous deflection proceeds in a linear-elastic manner proportional to load (up to failure), creep deflection is accelerated the more load is applied.

BRE believe that the tendency toward creep deflection is caused by the low modulus of the RAAC, in some cases lower than the design assumptions of the manufacturers, coupled to yield of AAC in the zone of transverse anchorage in the reinforcing bars and bond slip between reinforcing bars and AAC. BRE also noted that the deflection performance of some older RAAC panels worsened with time, possibly due to the formation of micro-cracks in the RAAC.

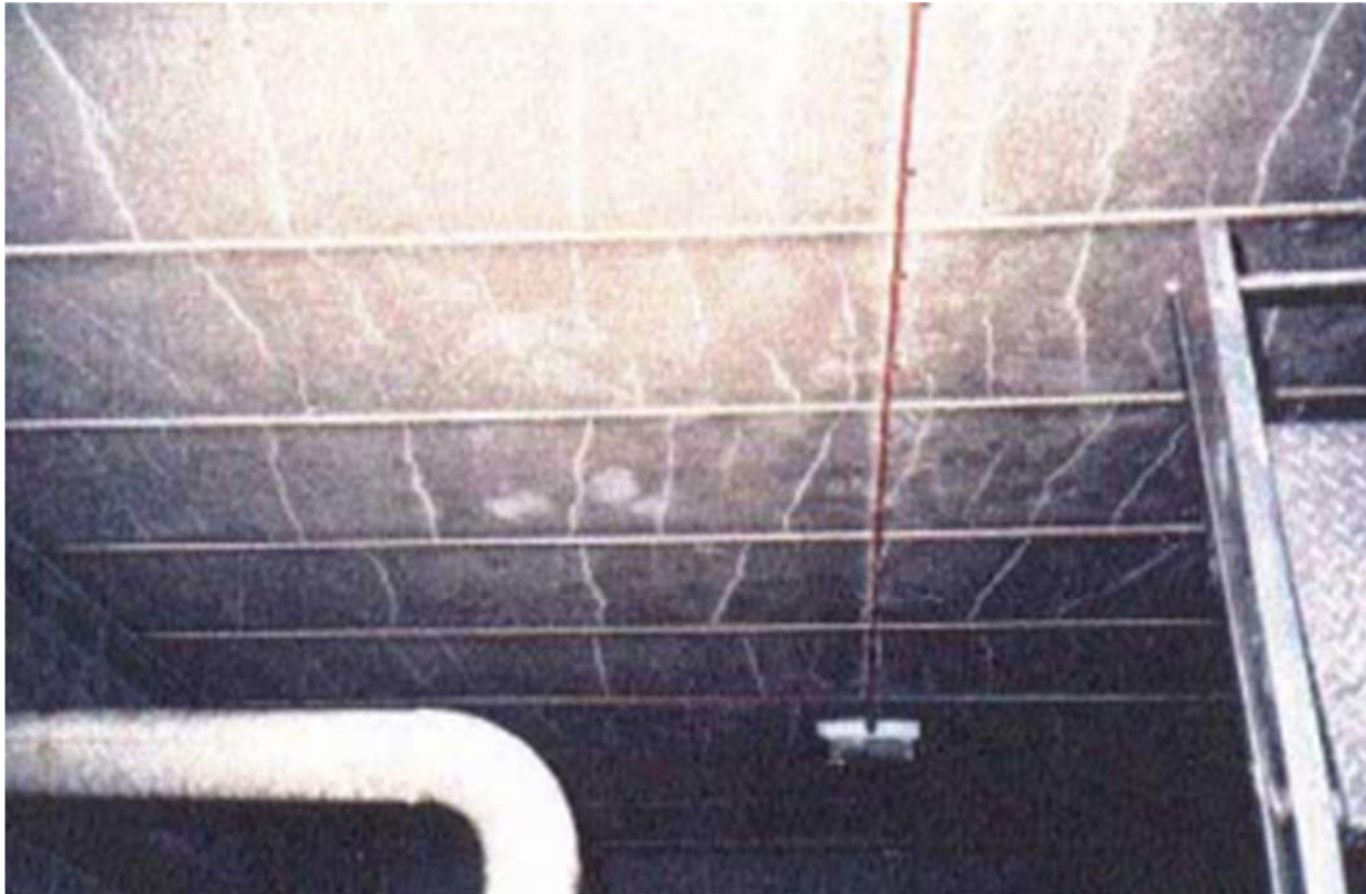

Figure 2 – Transverse cracking in a pre-1980 RAAC plank

BRE make the following recommendations for maintenance of RAAC planks over 20 years old:

- Reduce loading on RAAC roofs.
- Ensure all waterproof membranes are in good condition.
- Keep records of deflections of RAAC planks and inspect regularly.
- Inspect annually if the structure is in poor condition, deflections are greater than 1/150th of the span, or the planks are in a moist environment or exhibit rust staining.
- 5 yearly inspection intervals should be sufficient if there are no other problems, the structure is in good condition and deflections are less than 1/200th of the span.

In 1999 the Confidential Reporting on Structural Safety panel (SCOSS) reported on RAAC planks. They quoted from the BRE tests noted above and went on to concur with BRE's general conclusion that "pre 1980 RAAC planks do not appear to generally to present a safety hazard as they gradually deteriorate over time". However, the SCOSS report discusses concerns raised over the suitability of RAAC planks for permanent use. With reference to this particular concern, the then Department of the Environment, Transport, and the Regions (DETR) had discussions with the manufacturers and according to SCOSS following these discussions references to RAAC were removed from design standards and codes current and in preparation at the time. The precise reason for removal of these references is not stated, but the SCOSS commentary makes clear a link between concerns over structural safety of RAAC planks and the observation that mention of RAAC planks in design codes gives the material "an unjustified respectability, 'the impression that it can be used for permanent structures and that safety is in question".

2.3 FURTHER SCOSS REPORTING

In late 2018 a RAAC panel within a school collapsed suddenly which gave rise for the latest SCOSS report published in May 2019. The 'Failure of Reinforced Autoclaved Aerated Concrete (RAAC) Planks' report written by the Standing Committee on Structural Safety (SCOSS). The SCOSS report referred to above outlines details of a sudden collapse and a number of warning signs to be aware of that indicates panels may be near failure.

These are as follows:

- Significant cracking and disruption of the planks near the support.
- Any planks that have deflected more than 1/100 of the span, or a significant number of planks have deflections approaching this magnitude.
- Several of the planks having very small bearing widths (less than 40mm).
- The roof has been resurfaced since original construction; this is particularly an issue if the load has been increased or the resurfacing has a black finish, and the previous surface did not.
- There is significant ponding on the roof.
- The roof is leaking or has leaked in the past.

The recommended maximum deflection limits for the RAAC panels as defined in the above reports is 1/100th of the span.

Following shear failures in previously thought to be good condition RAAC planks the IStructE issued updated guidance - *Reinforced Autoclaved Aerated Concrete (RAAC Investigation and Assessment – Further guidance, IStructE, April 2023.*



Shear failure of RAAC plank – **NOT ST DAVIDS HALL**

3 RAPPEL SURVEY DATA

Rappel undertook intrusive survey investigations at St David's Hall between 25th September – 6th October 2023 under the instruction of WSP. The main aim of the investigations was to:

- Confirm end bearing length – Short bearing lengths increase the panels' vulnerability to vertical shear failure, therefore is critical to assess the structural integrity of the panels. At St David's Hall, supporting steel flanges are typically 146mm wide.

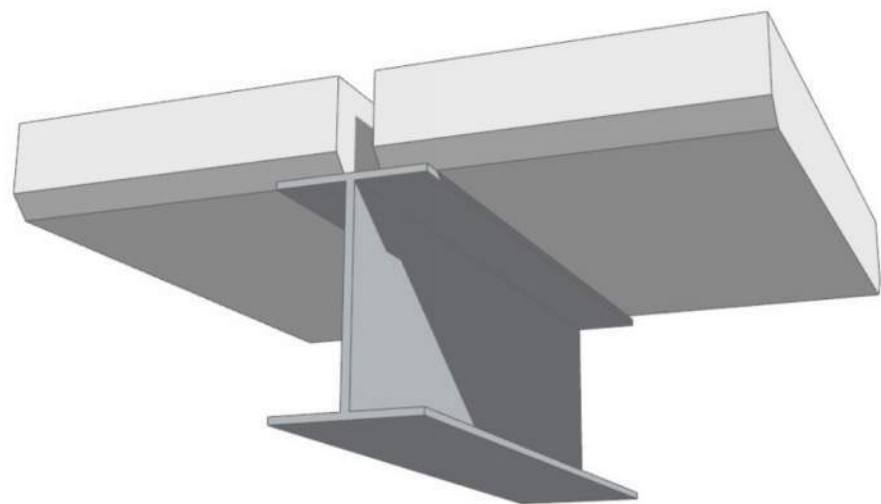

Sub-standard bearing on 100mm beam

- Identify position of steel reinforcement (intrusive investigation) – it has been evidenced that longitudinal reinforcement has sometimes been stopped short of the end bearing during installation. Where lack of continuity of the bars exists, there is a reduction in vertical shear capacity of the planks. Therefore, understanding the position of the rebar in the plank is key to understanding the robustness of the panels and their assumed capacity. This intrusive type of survey will also confirm the condition of the reinforcement and if it has been subject to any corrosion.

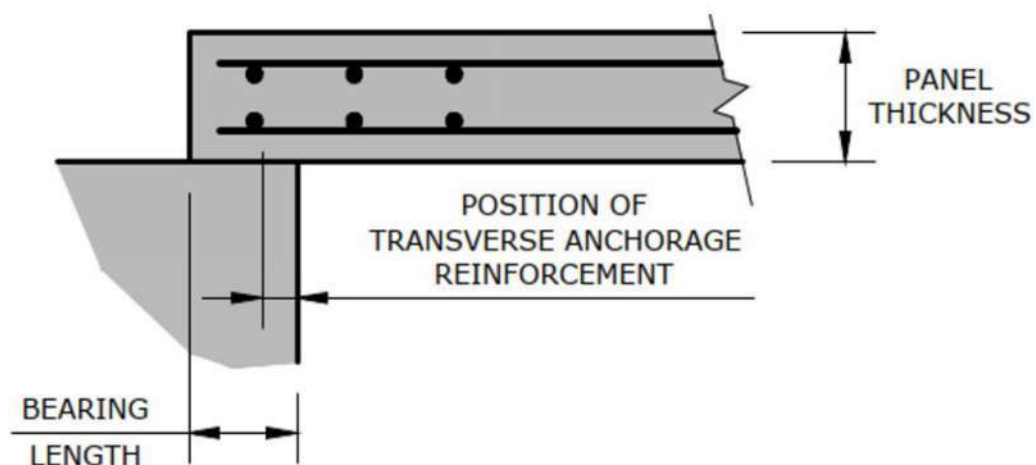

Figure 2 – End bearing configuration

3.1 METHOD OF INVESTIGATION

Measurements to confirm the RAAC plank end bearing over the steel beam flange, was undertaken using standard hand tools (small areas at a time). A steel measurement tool was used to hook to the rear of the plank via the 'V' grooved channel between planks, as highlighted in Figure 3-1. This method of measurement was limited to areas which were not obstructed by debris or infill between adjacent planks.

Measurements to confirm the presence and position of rebar were carried out by coring at the end bearing of the planks. Cores were as small as possible to minimise any damage to the existing RAAC panels.

Approximately 931 planks are present in the roof at St David's Hall, with their layout highlighted in Figure 3-2. This key plan identifies the locations of end bearing measurement (green) and intrusive investigation (red) carried out by Rappel.

Figure 3-1 - Current roof planks and steel purlin arrangement, view from underside of structure.

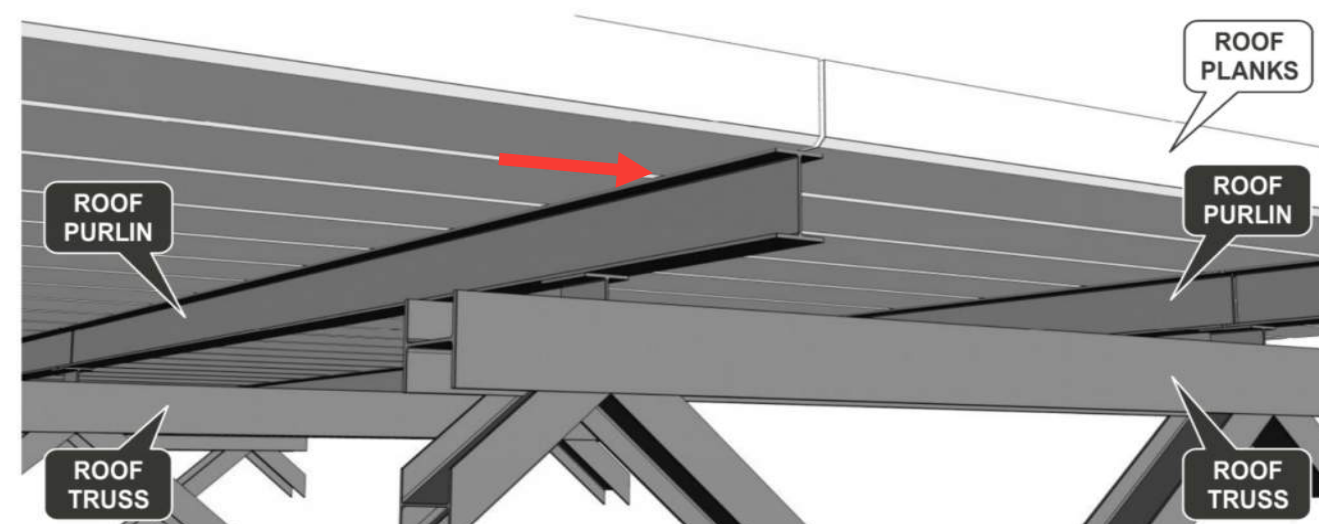
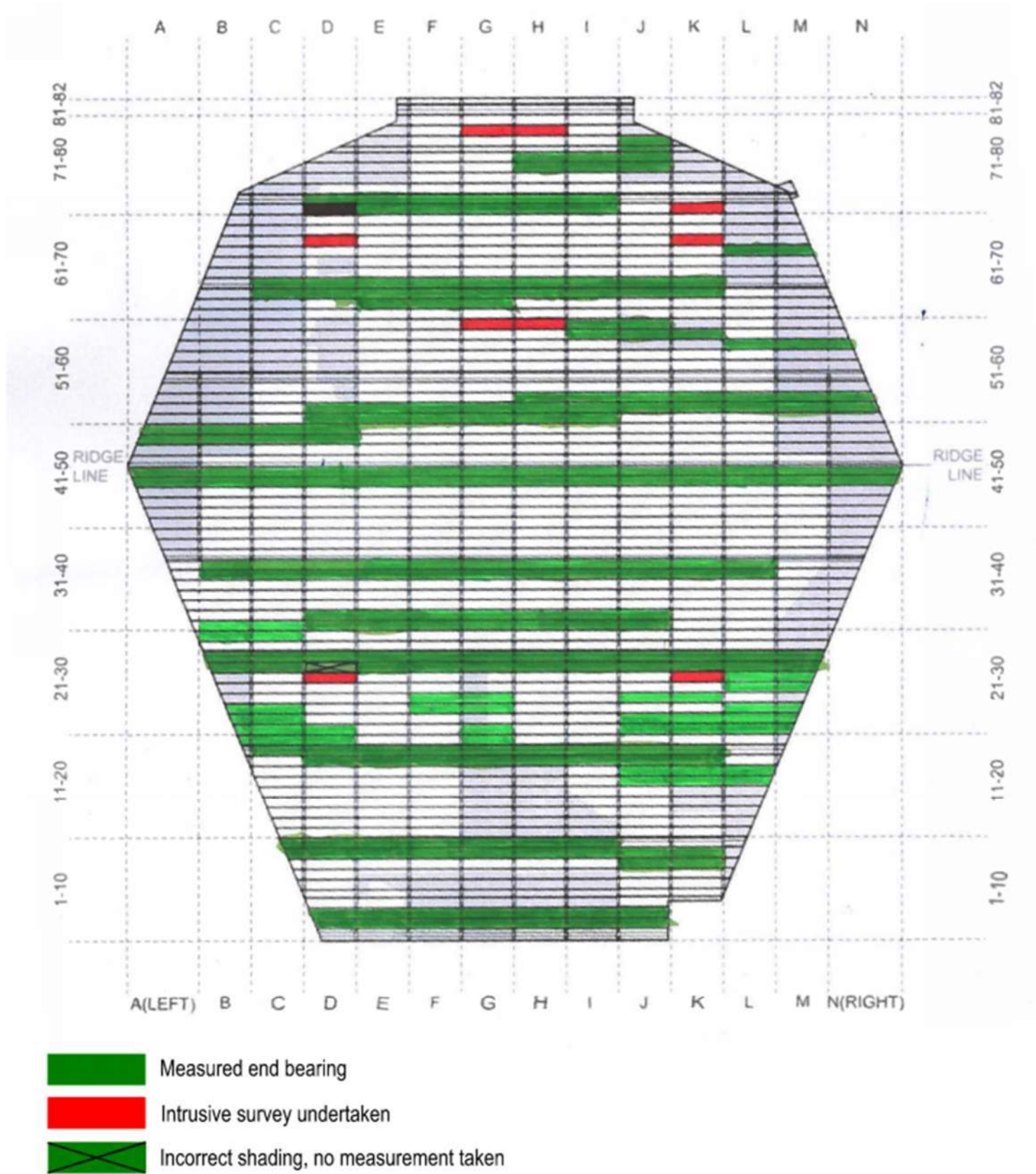

Figure 3-2 - St David's RAAC panel key plan



3.2 FINDINGS

3.2.1 END BEARING LENGTHS

A total number of 425 end bearing tests were undertaken by Rappel, with 38 of these unsuccessfully measured due to the presence of debris or infill of the 'V' grooved channel between planks.

As a result, out of CIRCA 931 planks at St David's, CIRCA 271 were tested at one of its ends to provide an end bearing measurement, covering approximately 29% of the total planks on site.

A summary of all end bearing lengths collected on site can be found in Appendix A and are tabulated according to the key plan in Figure 3-2. These values have been plotted independently and colour coordinated to highlight the range of end bearing across the site (Figure 3-3).

Minimum end bearing

Analysis of results at St David's Hall found the minimum measured end bearing length to be CIRCA 25mm in 3no. locations.

During the RAAC panel construction period (CIRCA 1950-1980), design codes of that time highlight an allowance of 45mm end bearing lengths for roof panels. In practise, construction tolerances could have resulted in further reduced bearing lengths. However, due to the limited access at time of survey an unseen broken corner to a plank may lead to an end bearing measured length as small as 25mm at the V grove location.

As per guidance provided in *Reinforced Autoclaved Aerated Concrete (RAAC Investigation and Assessment – Further guidance, IStructE, April 2023)*, a minimum bearing length of 75mm is now considered to be the standard minimum. Any bearing <75mm is considered substandard and presents an unacceptable risk for which remedial actions are recommended.

Maximum end bearing

Analysis of results found the maximum measured end bearing length to be 92mm.

A total number of 59 end bearing tests are ≥ 75 mm and are therefore deemed satisfactory in accordance with IStructE recent guidance.

Average end bearing

Over all measurements taken, the average end bearing was 62mm.

3.2.2 INTRUSIVE REINFORCEMENT INVESTIGATION

A total number of 10 intrusive investigations were conducted on site to examine the presence of rebar at the end bearings. All findings have been sketched and displayed in Appendix B, highlighting the end bearing length and position of transverse reinforcements at one of its ends. These figures have also been tabulated with relevant images on the following page.

From the 10 No. intrusive investigations we can conclude the following:

- 1 location has a transverse bar short of the bearing area & a longitudinal bar.
- 9 locations have a transverse bar over of the bearing area & a longitudinal bar.
- Plank bearing on the top flange of the UB ranges from 46mm to 84mm but is typically 68mm.
- Reinforcement appears in a good condition with no signs of corrosion.



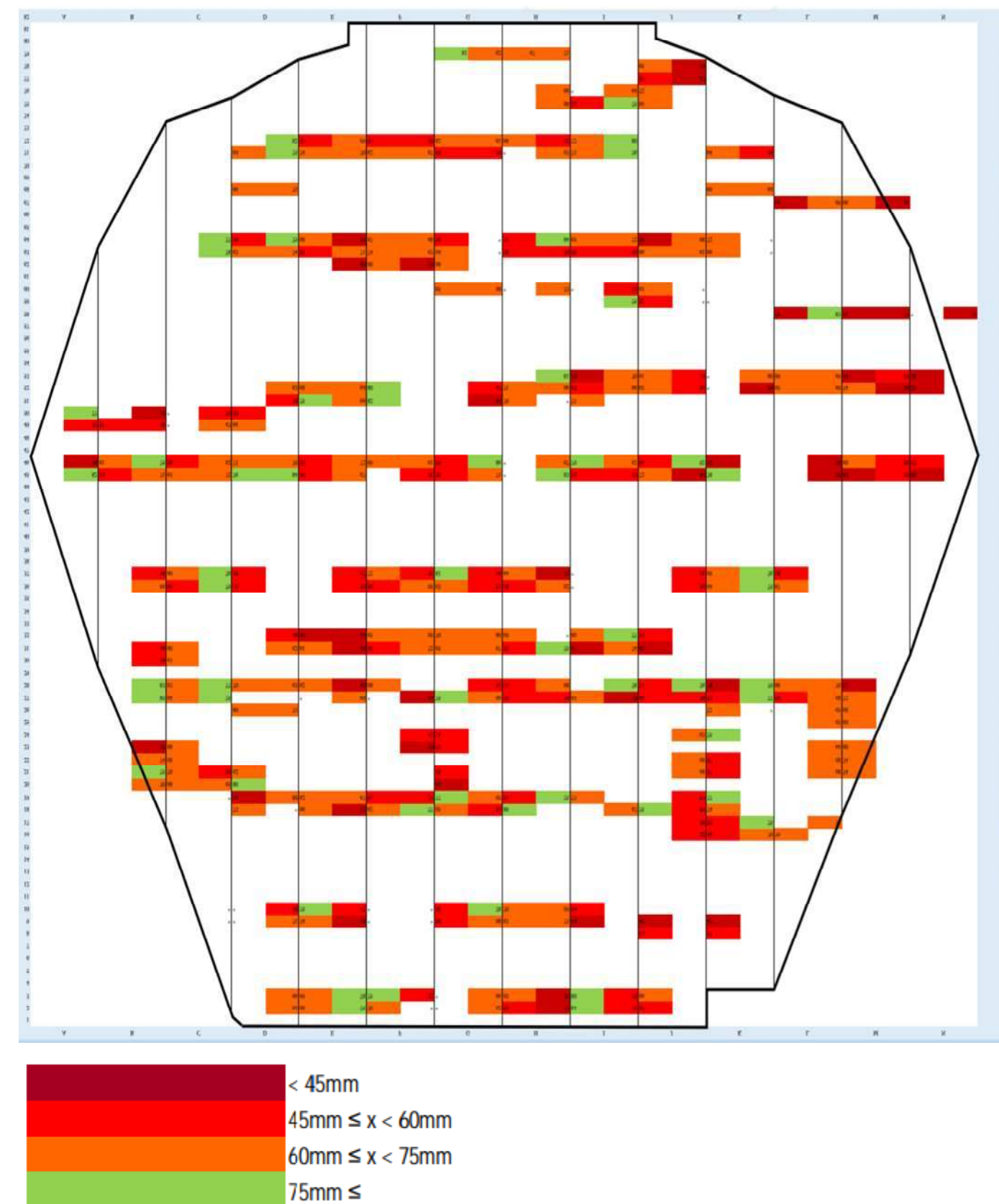



Figure 3-3 - End bearing length of RAAC roof panels







The findings of the intrusive investigations are summarised in the following table. Please note the following:

- Bearing lengths have been classified as per the colour coded system shown in Figure 3-3.
- Values for extent of transverse bar in bearing zone have been detailed red where no transverse reinforcement was found above the bearing length.

Table 3-1 - Summary of intrusive RAAC panel investigations

Location	Bearing on UB, RHS (mm)	Bearing on UB, LHS (mm)	Extent of transverse bar in bearing zone (mm)	Images
D26	71	60	60	 
K26	Measurement not obtained due to obstruction by debris or infill between adjacent planks.	72	52	 
H60	73	Measurement not obtained due to obstruction by debris or infill between adjacent planks.	68	 

K71	46	64	52	
G60	68	65	20 (inset of bearing length).	
K68	64	66	56	

D71	84	64	51	
D68	71	66	55	
H79	71	67	45	
G79	62	81	47	

4 SURVEY SUMMARY

'Poor bearing is a significant risk to the integrity of RAAC roof panels. The codes of practice associated with the design of RAAC from the 1950's to 1980's were CP114 Reinforced Concrete in Buildings and CP116 Structural Use of Precast Concrete.

These codes recommended minimum end bearings of only 45mm for roof panels and 60mm for floor panels. In practice, construction tolerances could have resulted in reduced bearing lengths.

To anchor longitudinal reinforcement, RAAC panels require transverse reinforcement over the bearing support. As noted by testing undertaken by the BRE (BRE IP 10/96), absence of transverse reinforcement at the end bearing can substantially impact on panel performance. The inspection of several buildings has identified that with short bearing lengths there is a risk that this critical anchorage reinforcement can be absent over the support face, presenting an increased risk of panel failure.

For this reason, a minimum as built bearing length 75mm is now considered to be necessary. Any bearing less than 75mm would be considered substandard and present an unacceptable risk to panels from shear failure or slippage and remedial actions are recommended.' RAAC Investigation & Assessment – Further Guidance, IStructE 2023.

Although visual inspection of the panels generally indicates good condition, some do exhibit properties which cause it to fall under the red and red (critical) risk categories as outlined by IStructE (**Figure 4-1**).

Red – End bearing checks undertaken by Rappel highlight a large majority of bearings <75mm, with the average bearing length found to be 62mm. Approximately 279 No. readings were found to be between 45mm ≤ X <75mm, which equates to 66% of readings taken.

Red (critical) – As identified on the intrusive surveys, 1 out of the 10 survey points were found to lack required transverse reinforcement, equating to 10%. Extrapolating this value, we would therefore anticipate 93 No. panels to not have a transverse bar over the support over the entirety of the site.

Red (critical) – 49 No. end bearing measurements were found to be <45mm, which equates to 12% of readings taken. Due to these being below the original design criteria (45mm), they are to be classified as red (critical).

Figure 4-1 – Support/bearing condition risk categories (RAAC Investigation & Assessment - Further Guidance, IStructE 2023)

Support / bearing condition	Risk category
Bearing investigated and found to lack required transverse reinforcement	Red (critical)
Cut or modified panels, including where cut panels are supported on proprietary hangers	Red (critical)
Bearing <75mm with transverse anchorage reinforcement	Red
>75mm with transverse anchorage reinforcement	Green

LIMITATIONS

Please note that only a proportion of all RAAC panels at St Davids Hall have been examined.

5 REMEDIAL OPTIONS

A potential remedial action could be proposed to improve the end bearing condition of the RAAC panel such as supplementary steel support bracketry.

5.1 SUPPLEMENTARY STEEL SUPPORT BRACKETRY

A potential remedial action would be the introduction of steel angles bolted to the existing steel UB purlins (Figure 5-1). Angles of CIRCA 1.8m long would support the end of 3 RAAC panels providing an enhanced end bearing, mitigating any risks associated with known deficiencies/unproven end bearing conditions. Installation of the supplementary bracketry would require the drilling of the existing UB's to receive the new bolts.

Please note, this remedial solution would require further detailed structural design should Cardiff City Council wish to proceed.

Figure 5-1 - Remedial solution - supplementary steel support bracketry solution

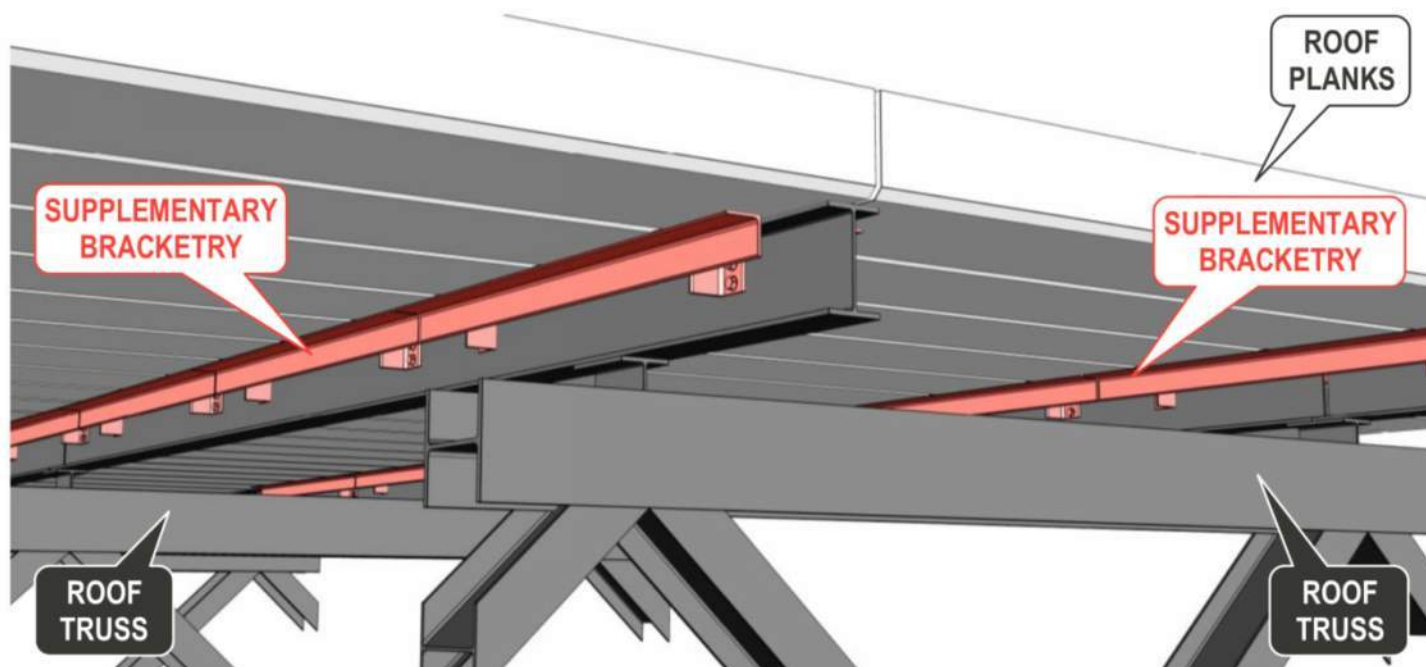

6 CONCLUSION

According to all investigative results collected and further engineering judgement, St David’s Hall will fall under the **Red – Critical Risk category**.

The IStructE Guidance therefore requires, as presented in the table extract below that urgent remedial works are required. This may include taking out of use or temporary propping allow safe ongoing use of the building.

This report has identified the urgent temporary remedial works that would be necessary. These would entail significant access to the roof areas either through roped access or scaffolding. Given that these works would be considerable, and there remains a risk of further deterioration of the panels, replacement of the RAAC panels should be given consideration.

In considering replacement structures, consideration needs to be given to the self-weight / dead loading of the replaced element and the acoustic performance of the theatre space in terms of mass and surface hardness.

The duty holder of the building should next undertake a risk assessment of the building considering the risks identified in this report, the use of the building and the published guidance from the HSE.

Figure 6-1 – RAAC Assessment category and associated risk types (RAAC Investigation & Assessment - Further Guidance, IStructE 2023)

Assessment category	Risk category	
Red	Critical risk	Requires urgent remedial works which may include taking out of use or temporary propping to allow the safe ongoing use of a building. Depending on the extent, this may be part or all of the building. Combined with awareness campaign for occupants including exclusion zones.
	High risk	Requires remedial action as soon as possible. Combined with awareness campaign for occupants, which may include exclusion zones, signage, loading restrictions and the need to report changes of condition, eg, water leaks, debris, change in loading, etc.
Amber	Medium risk	Requires inspection and assessment on a regular basis, eg, annually. Combined with awareness campaign for occupants, which may include signage, loading restrictions and the need to report changes of condition, eg, water leaks, debris, etc.
Green	Low risk	Requires inspection and assessment occasionally, say three year period depending on condition. Combined with awareness campaign for occupants, which may include signage, loading restrictions and the need to report changes of condition, eg, water leaks, debris, etc.

Appendix A

RAPPEL SURVEY DATA - END BEARING MEASUREMENTS



Location: E 63+64, D 63+64, C 63+64

Location: F 63+64, G 63+64, H 63+64

64

64

77 \leftrightarrow 56 75 \leftrightarrow 68 39 67 68 \leftrightarrow 50 * \leftrightarrow 53 84

63

63

78 \leftrightarrow 63 74 \leftrightarrow 55 71 74 63 \leftrightarrow 64 * \leftrightarrow 58 58

148

147

148

148

148

149

Location: I 63+64, J 63+64, K 63+64

Location:

64

65 72 \leftrightarrow 38 68 \leftrightarrow 72 *

\leftrightarrow

* \leftrightarrow

63

50 56 \leftrightarrow 66 61 \leftrightarrow 66 *

\leftrightarrow

* \leftrightarrow

149

148

148

\leftrightarrow

\leftrightarrow

Location: F 45/46

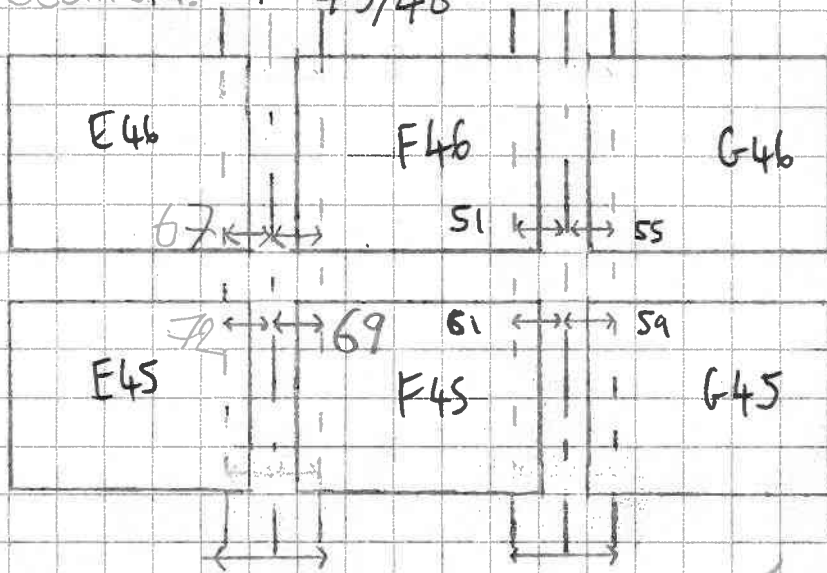

Location:

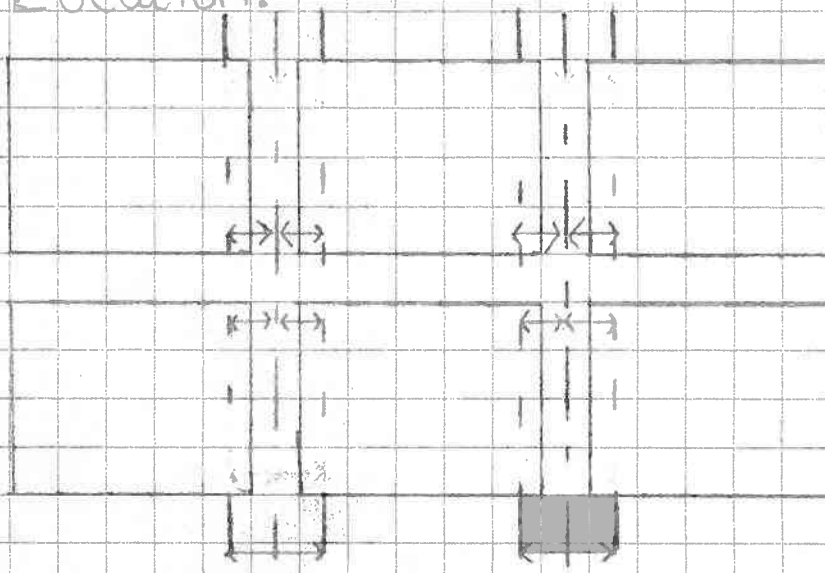

TJ
27/9

Location:

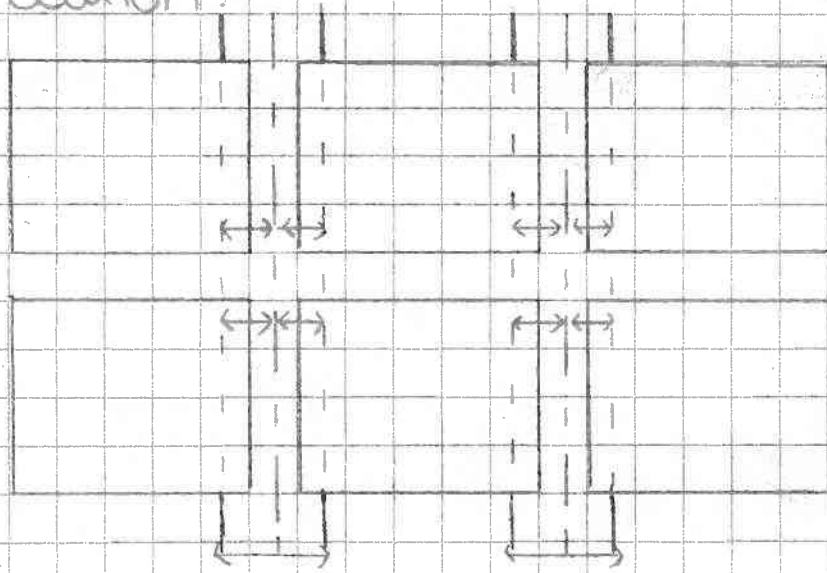

Location:

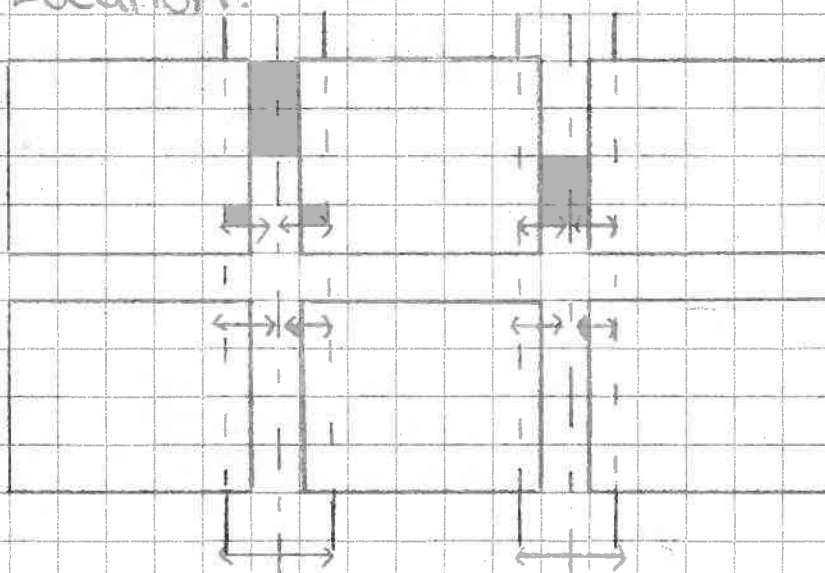

Location: F36

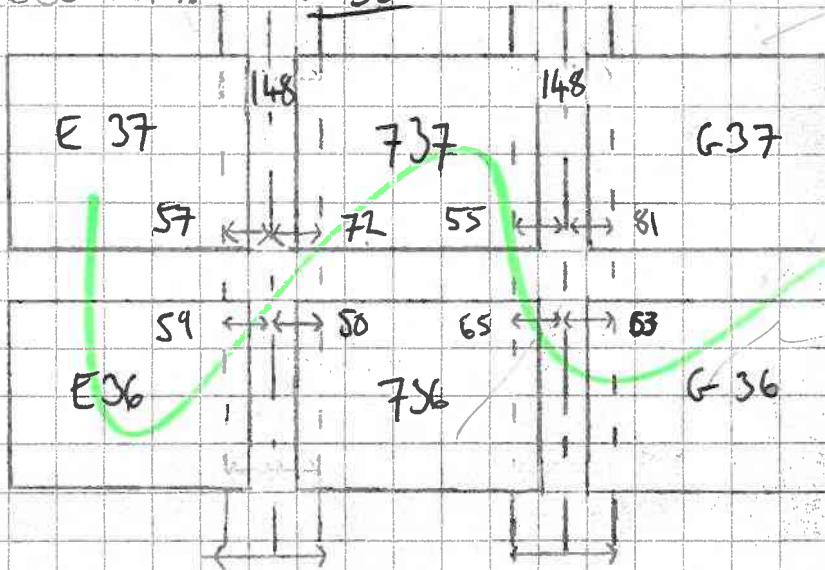

Location: F36

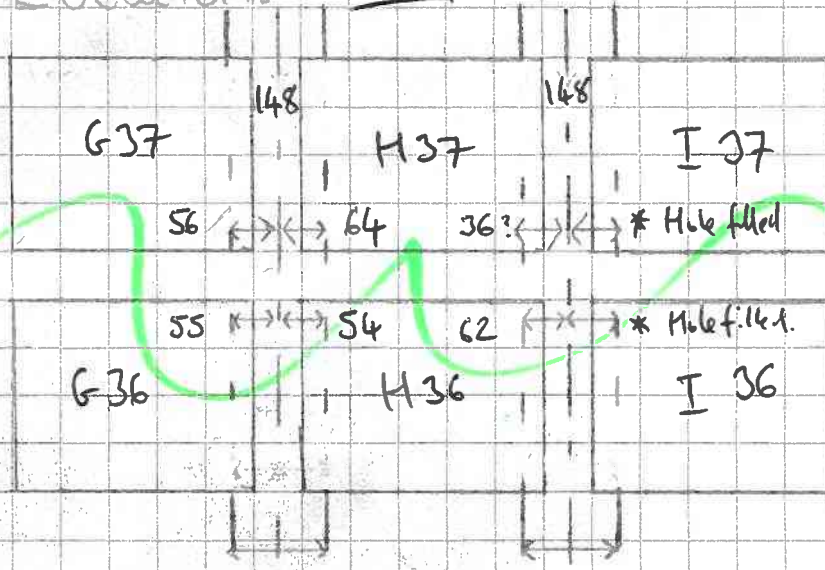

TJ
27/9

Location: B46

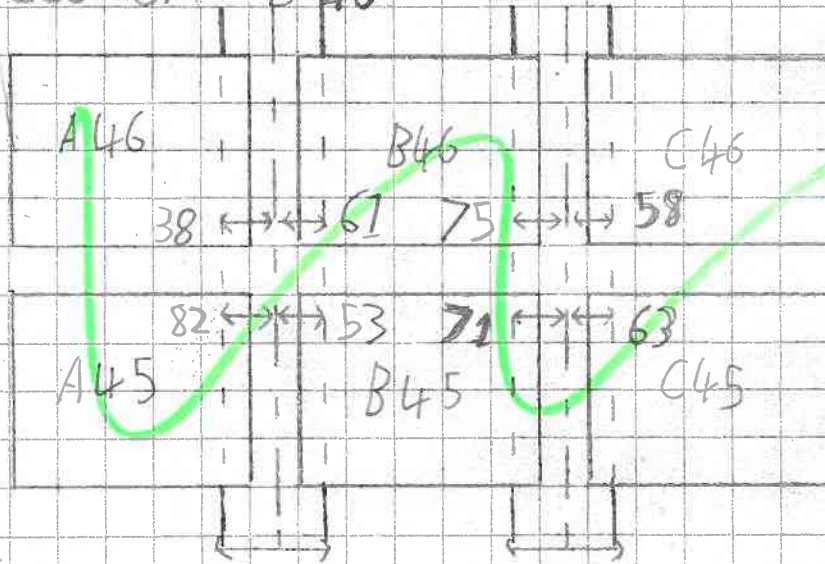

Location: D46

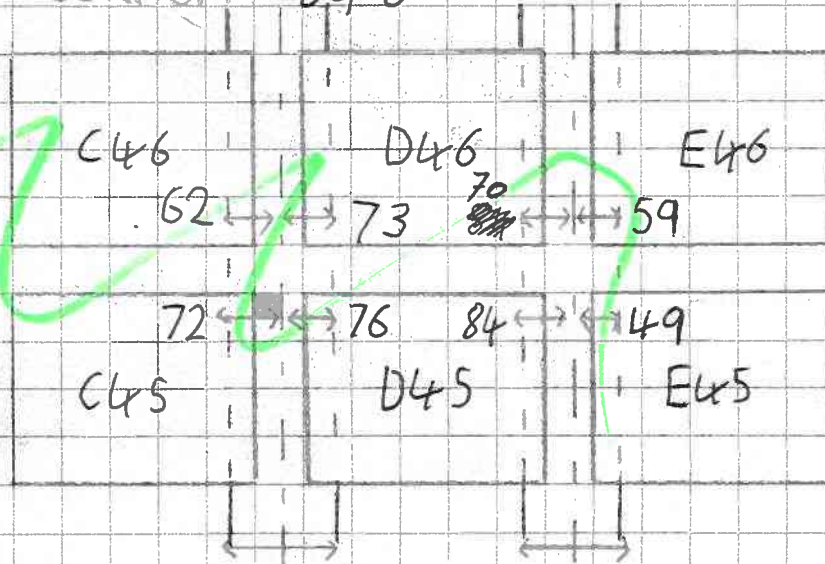

Location: D18

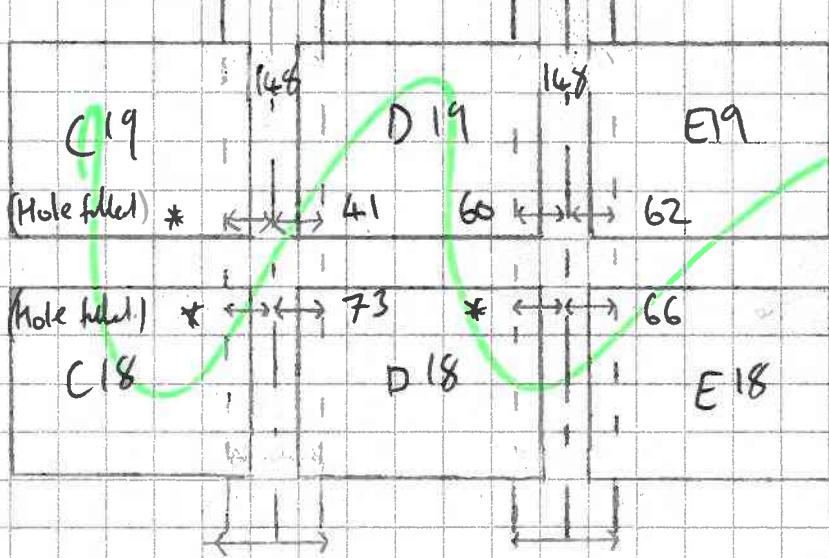

Location: F18

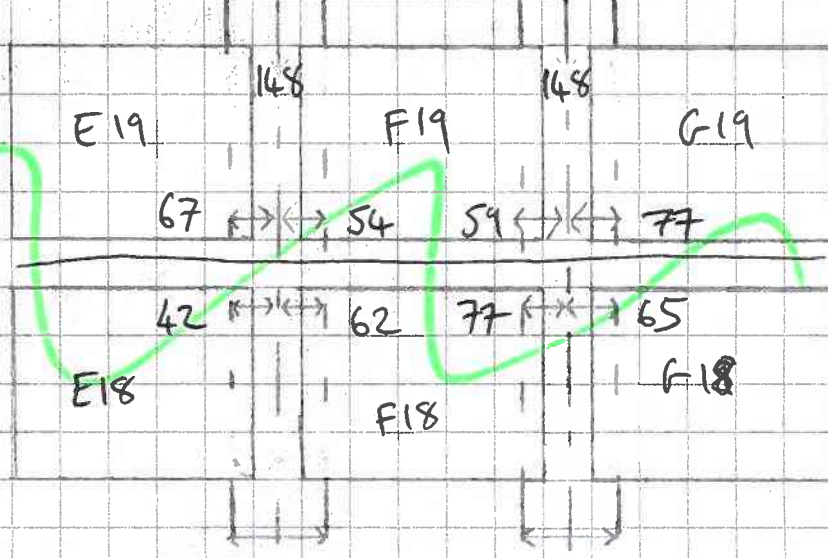

TJ
26/9

Location: C27

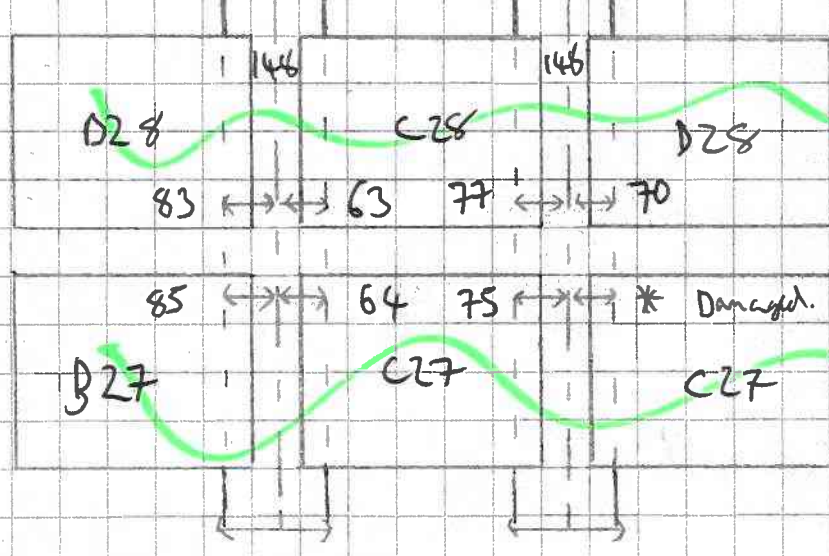

Location: E27

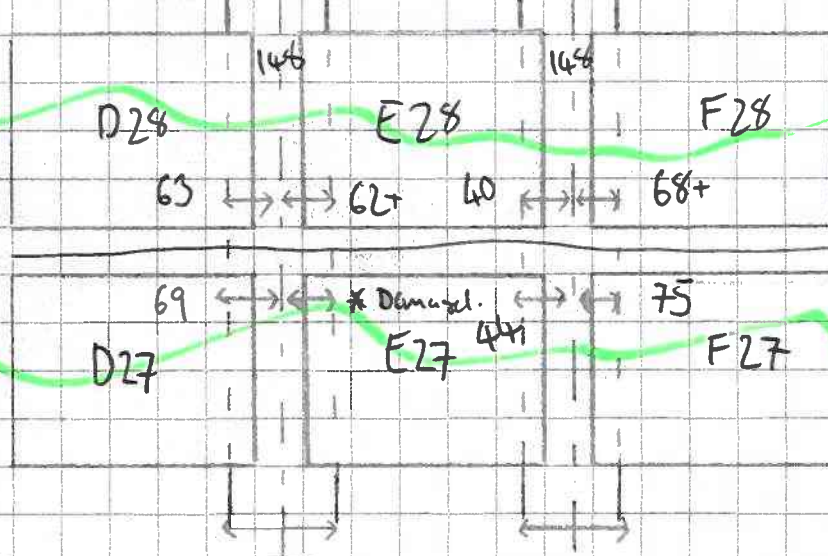

Location: E 31

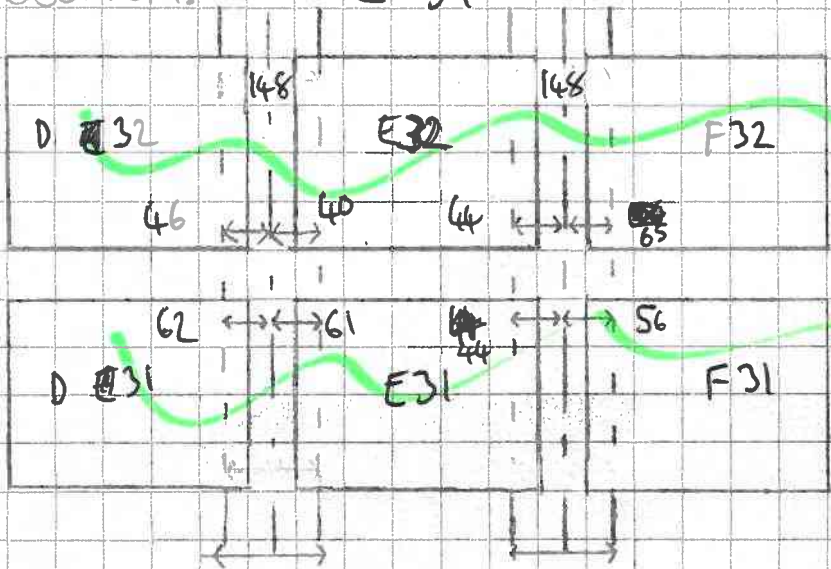

Location: G 31

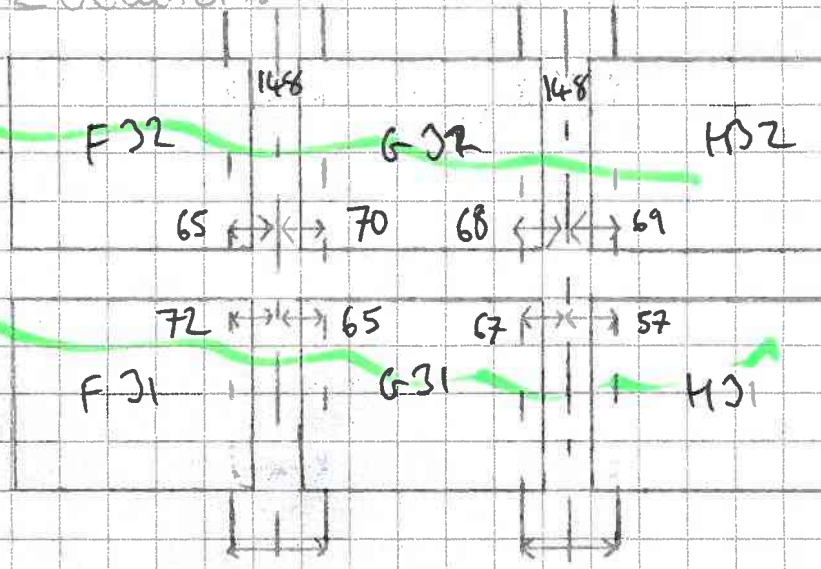

TJ
26/9

Location: I 31

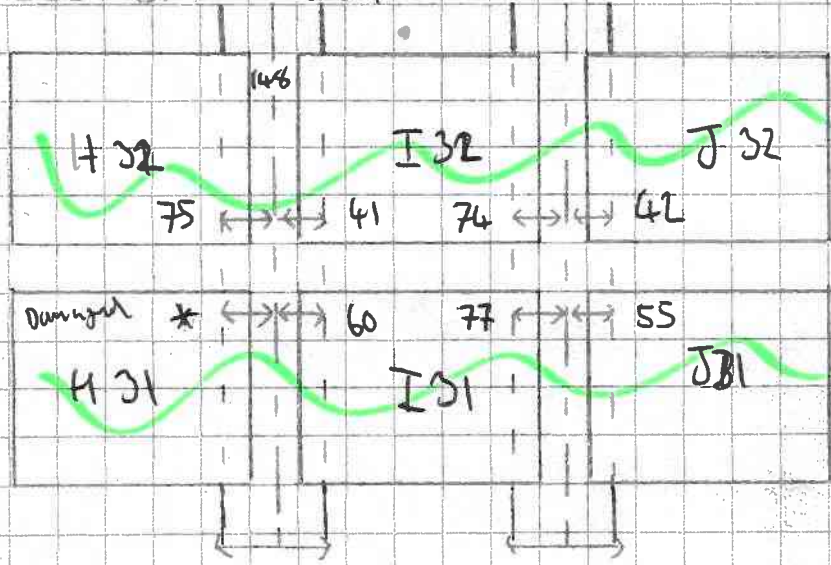

Location:

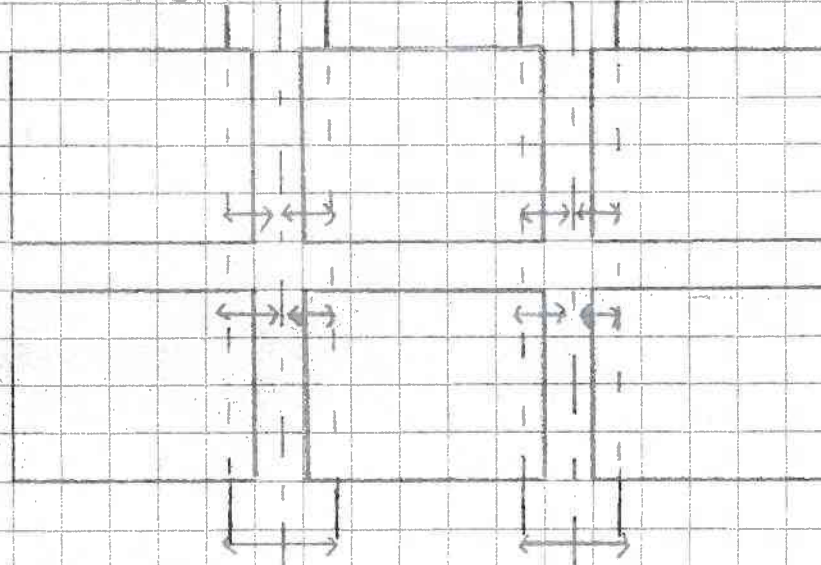

Location: K36

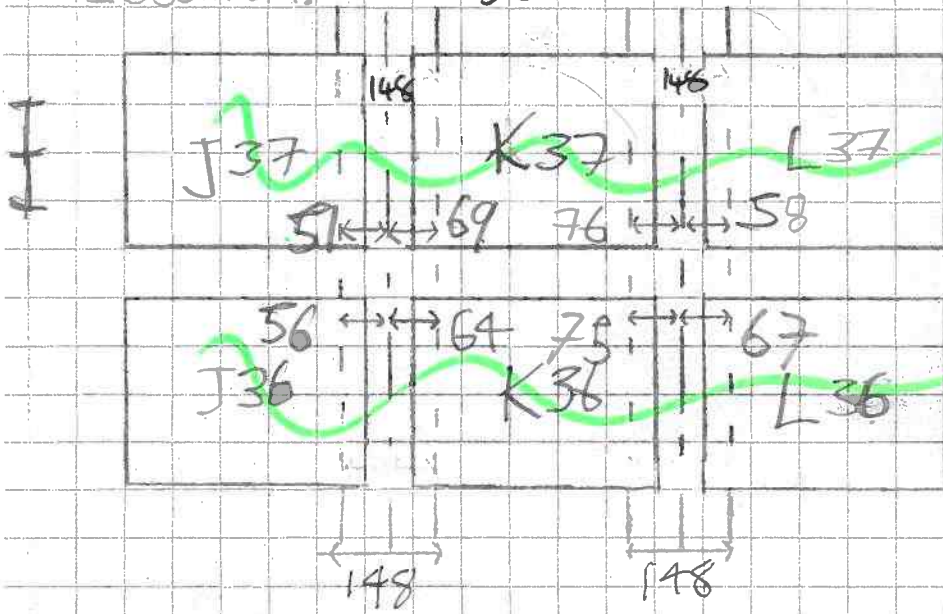

Location: C36

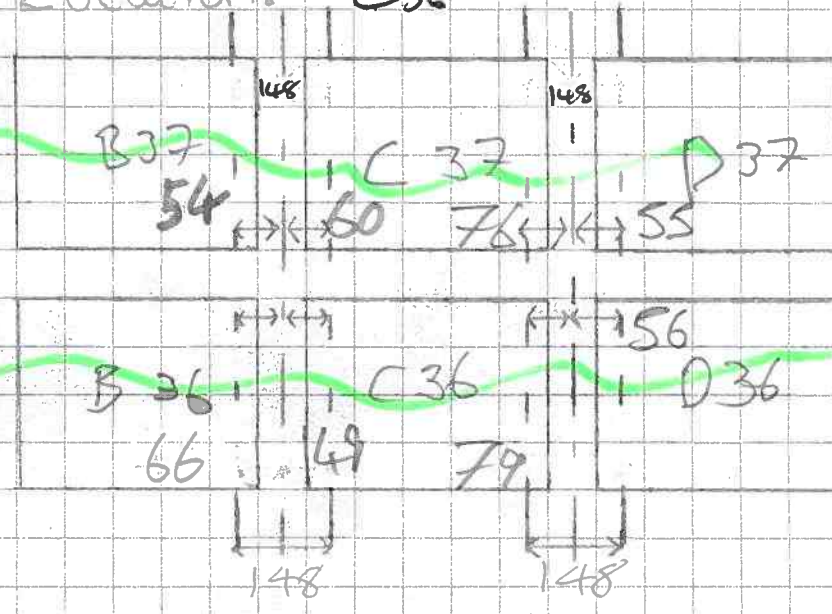

Location:

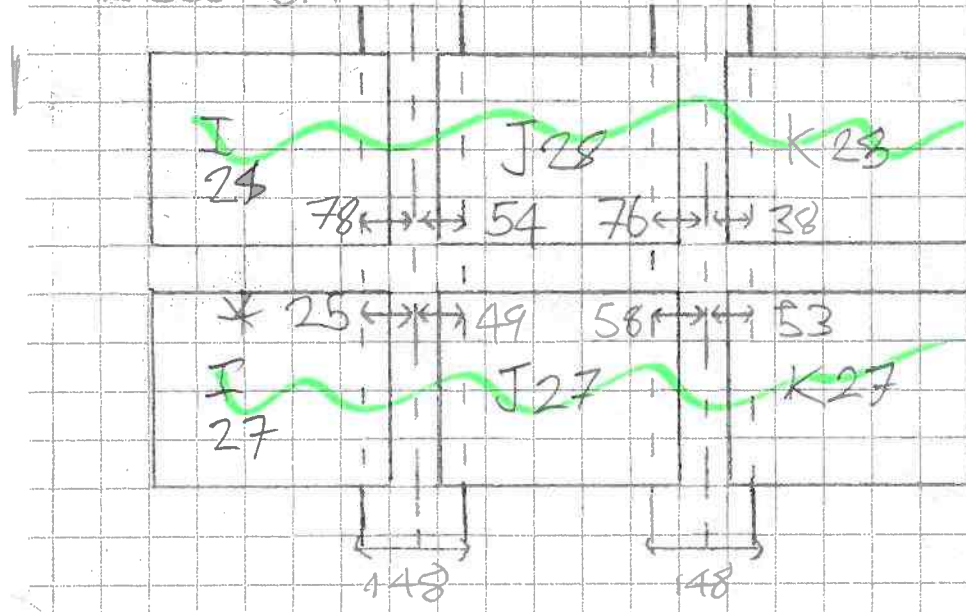

Location:

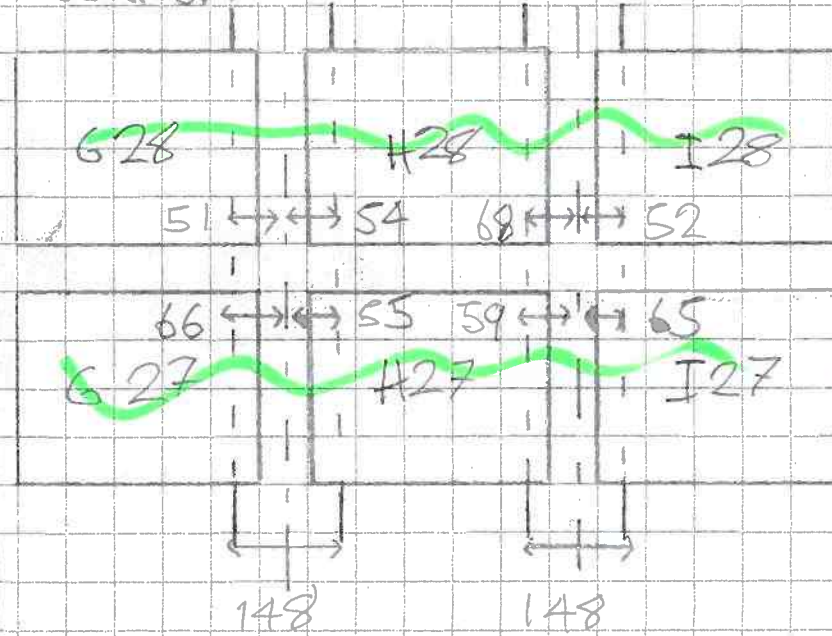

Location: J18

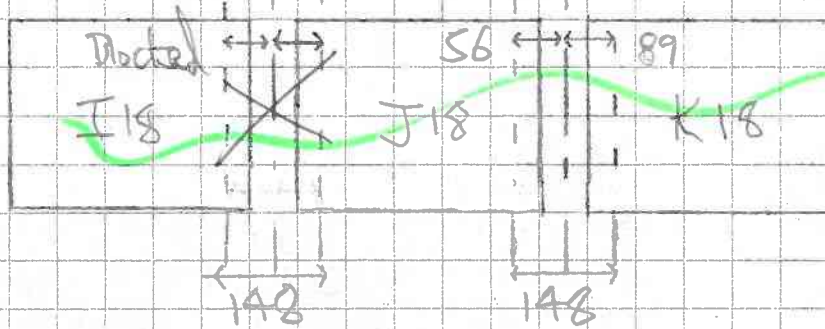
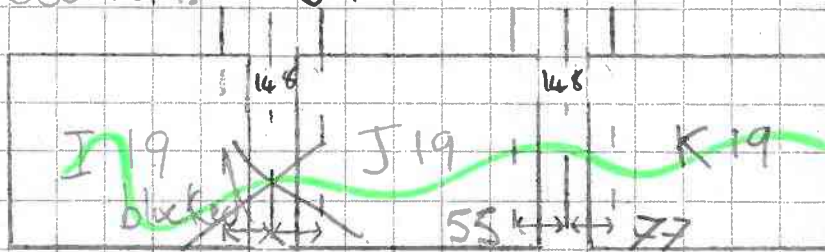

Location: H18

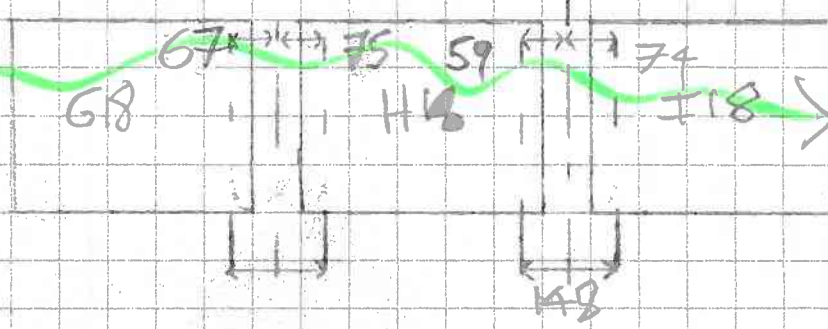
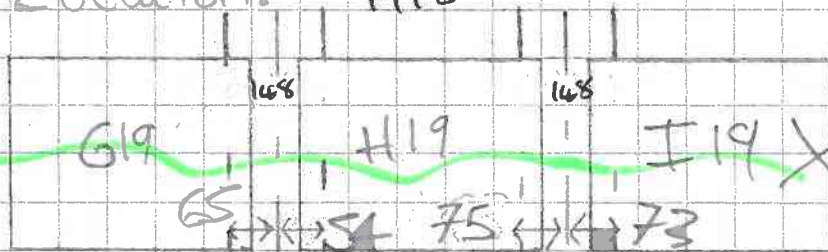

Location: L27

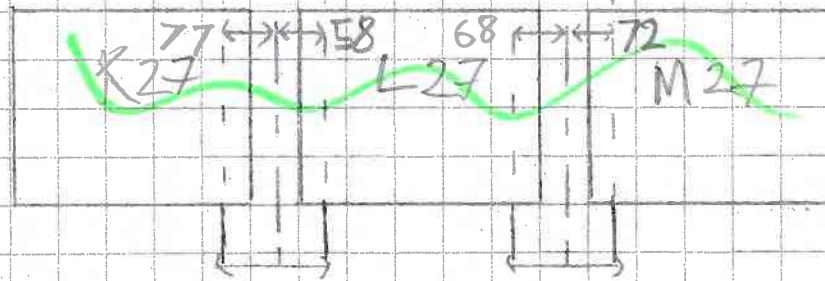

Location: J27

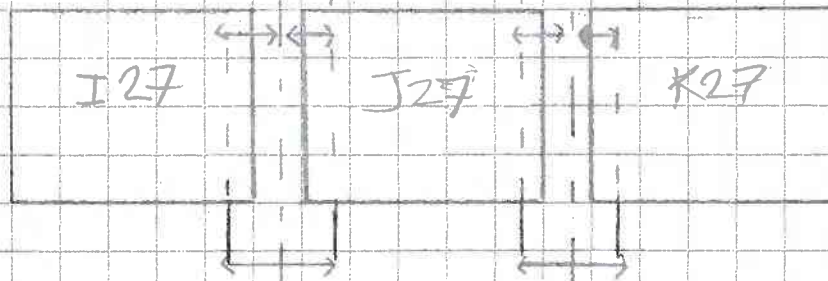
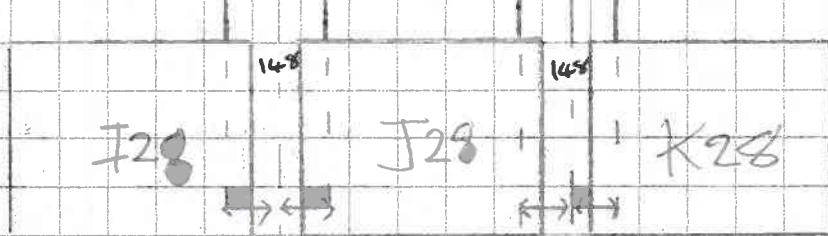

Location: 148

148

148

Location: 148

148

148

148

H53

I53

J53

K53

L53

M53

N53

81

40

70

61

59

*

60

69

69

44

49

26

H52

I52

J52

K52

L52

M52

N52

81

40

66

63

56

*

39

65

6

64

36

25

* OBSTRUCTED

Location:

Location:

K53

K52

↔

↔

↔

↔

↔

↔

↔

↔

↔

↔

↔

↔

Location:

★ OBSTRUCTED Location:

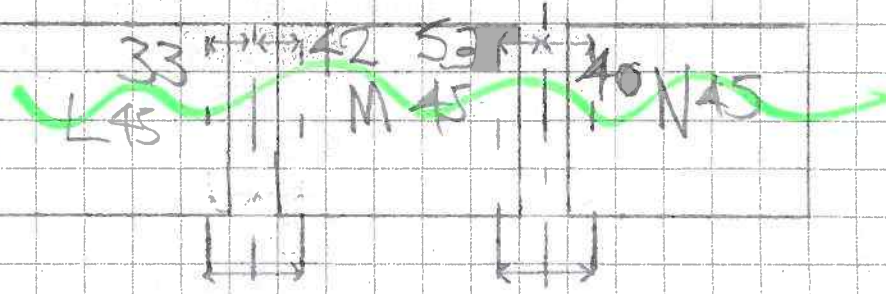
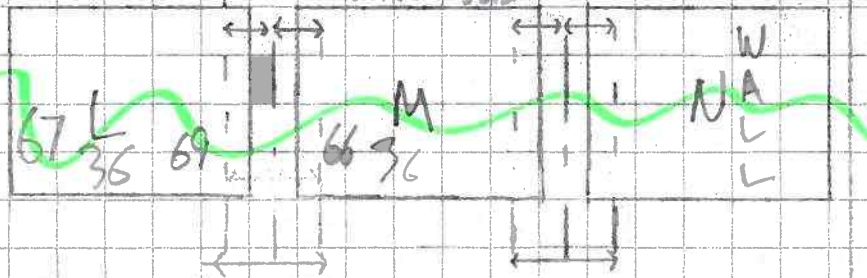
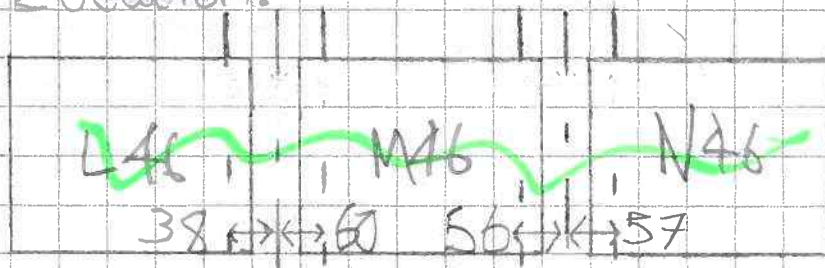
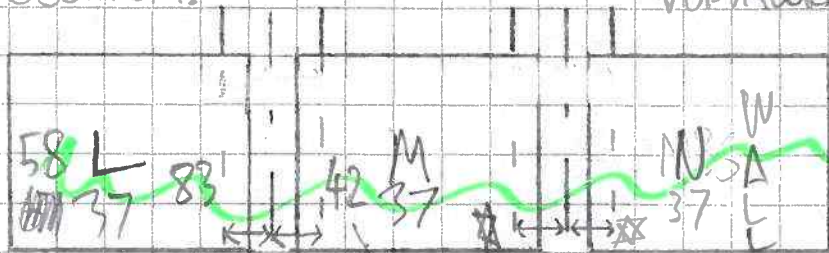

Location:

Location:

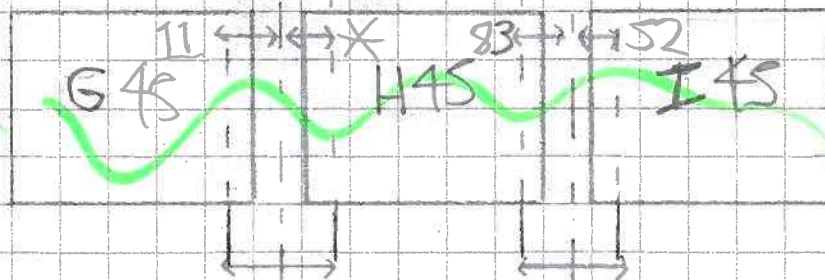
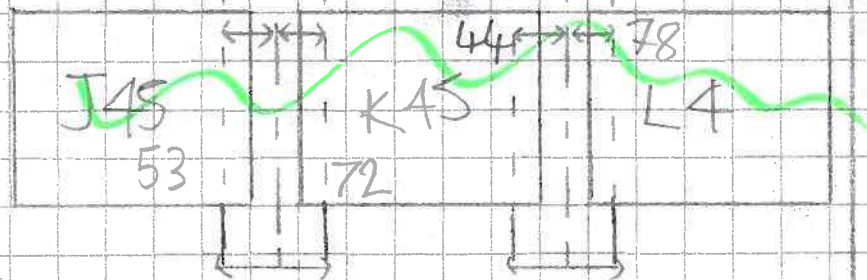
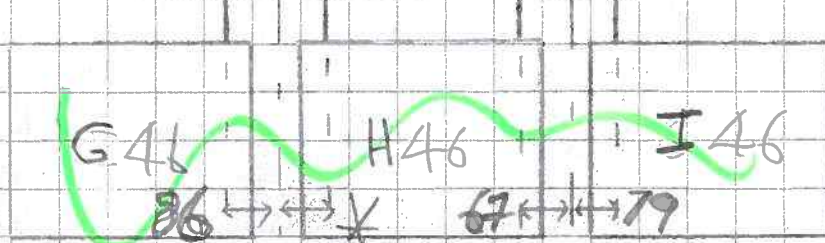
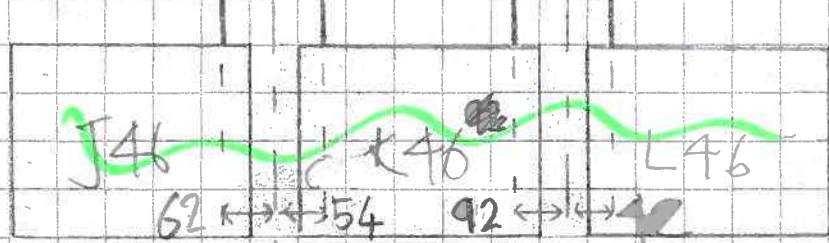

M37 - APPEARS TO CONTINUE FURTHER INTO THE WALL LONGER SLAB

Location:

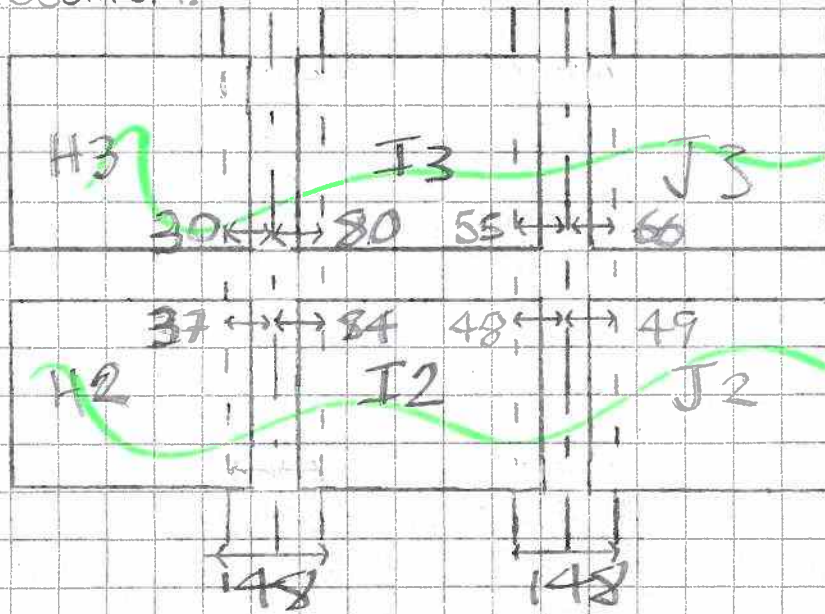

Location:

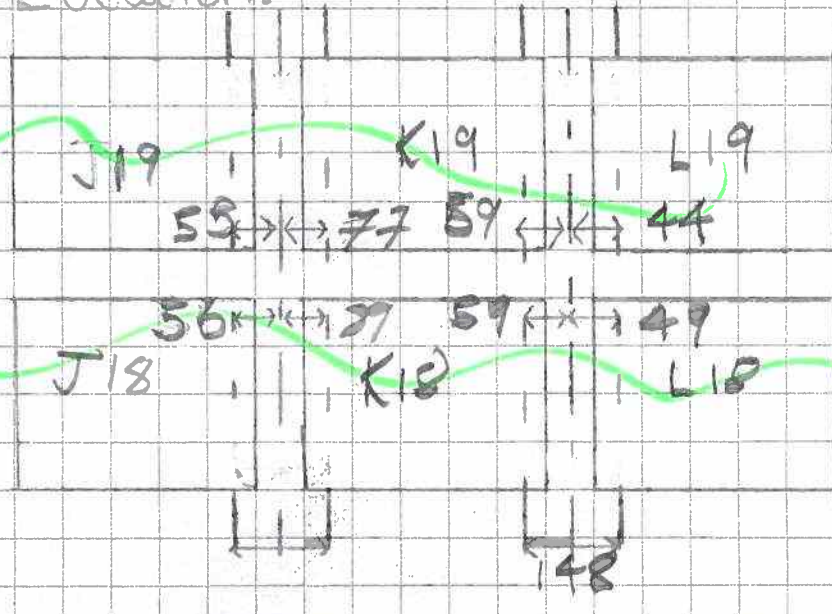

AB
7519

Location:

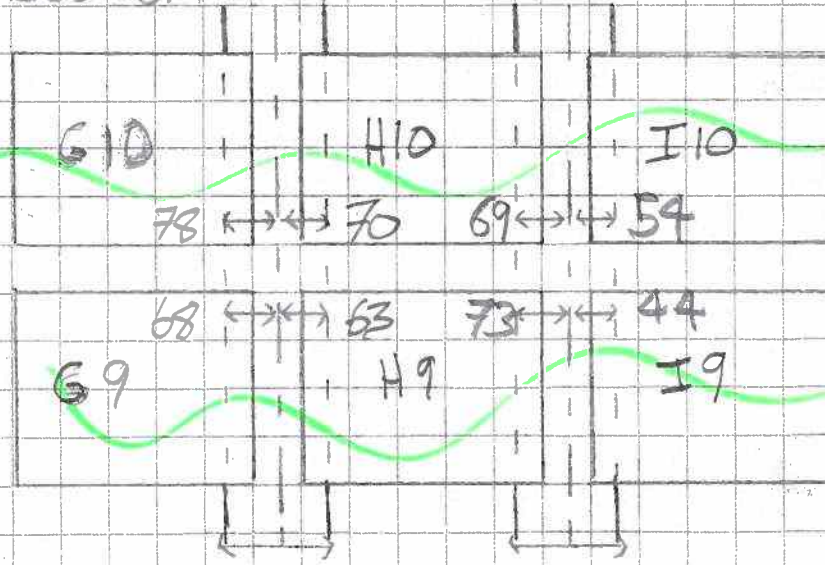

Location:

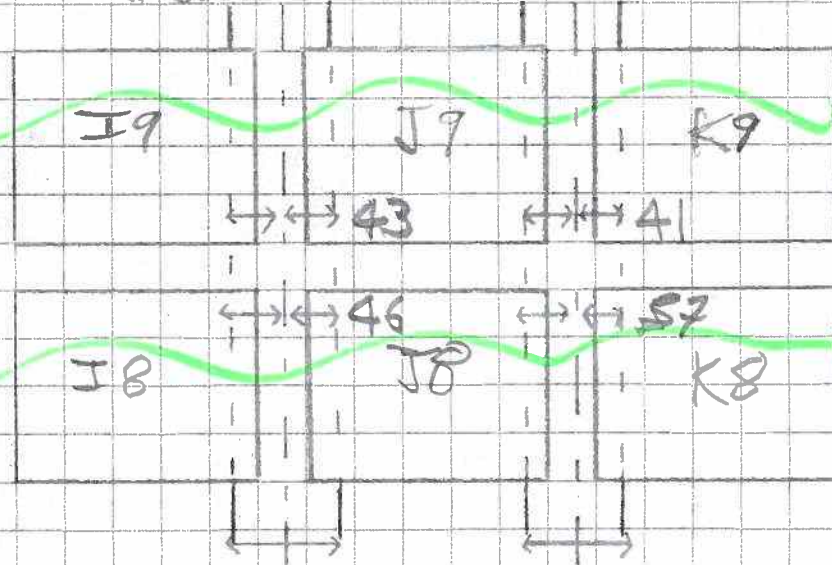

Location: E 02

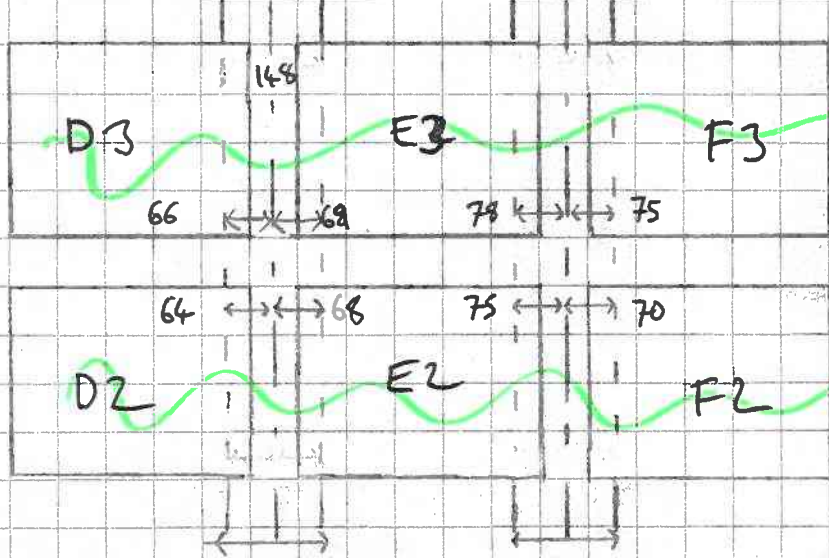

Location: G 02

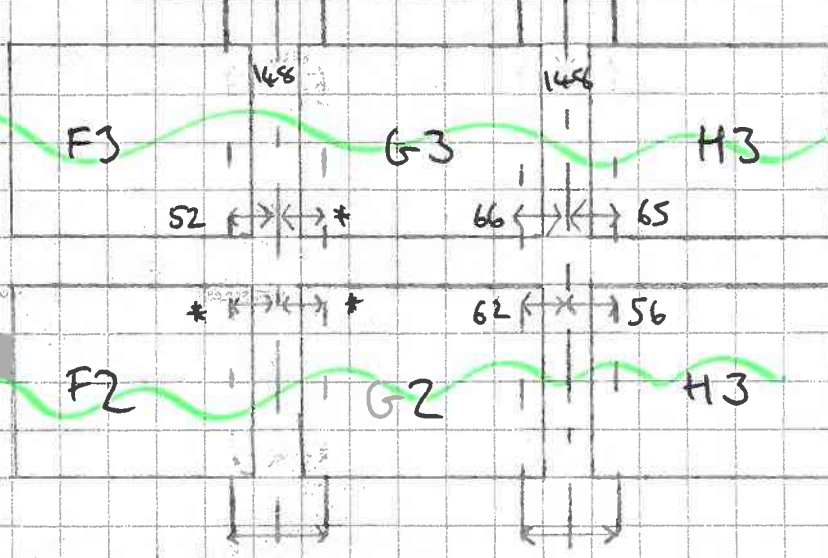

TJ
25/9

Location: D 09

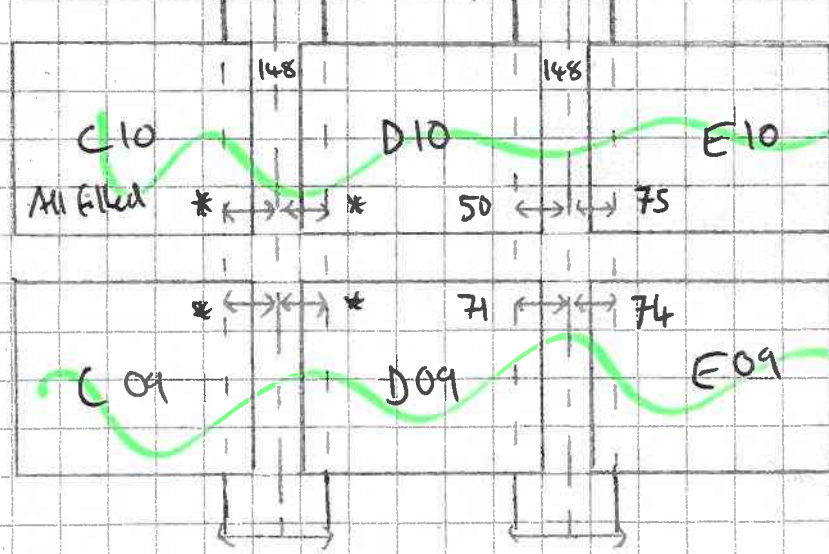

Location: F 09

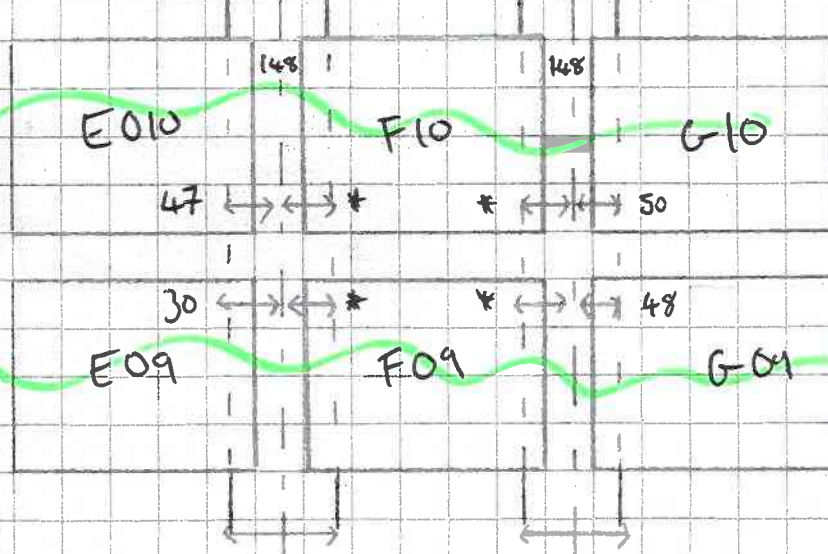

Location: C 49

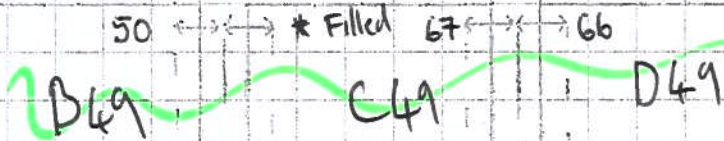
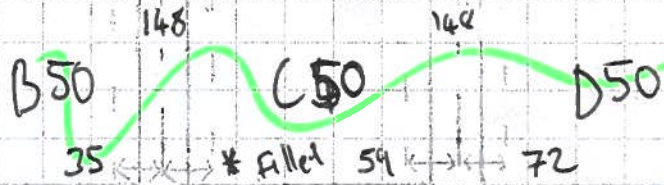

Location:

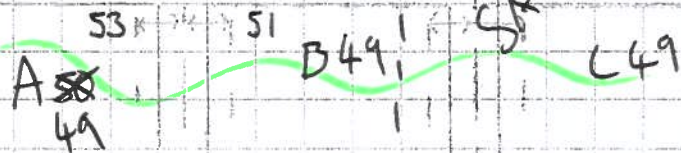
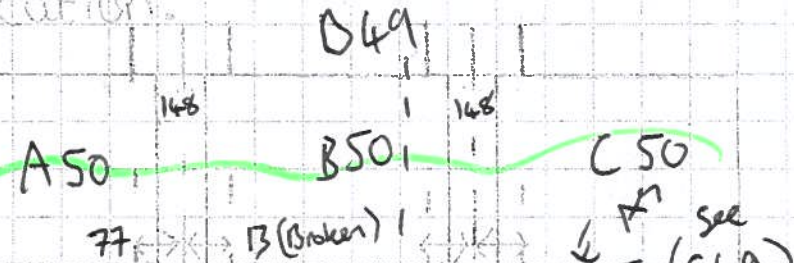

* 1
TEAM
TJ
28/9

Location: D 51/52

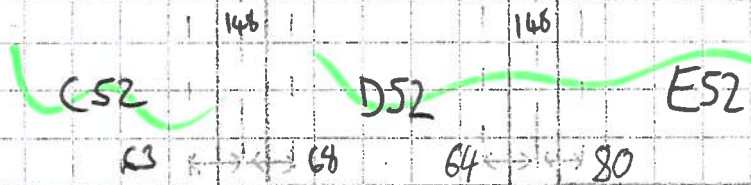

Location: G 51/52

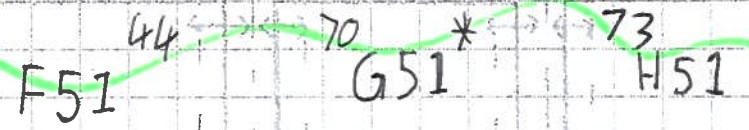
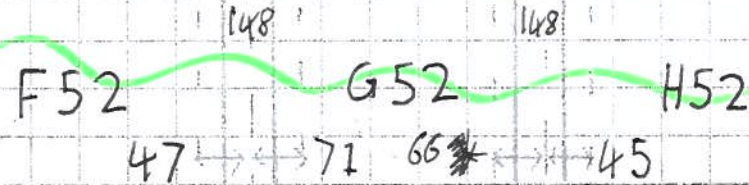

Location: ES9

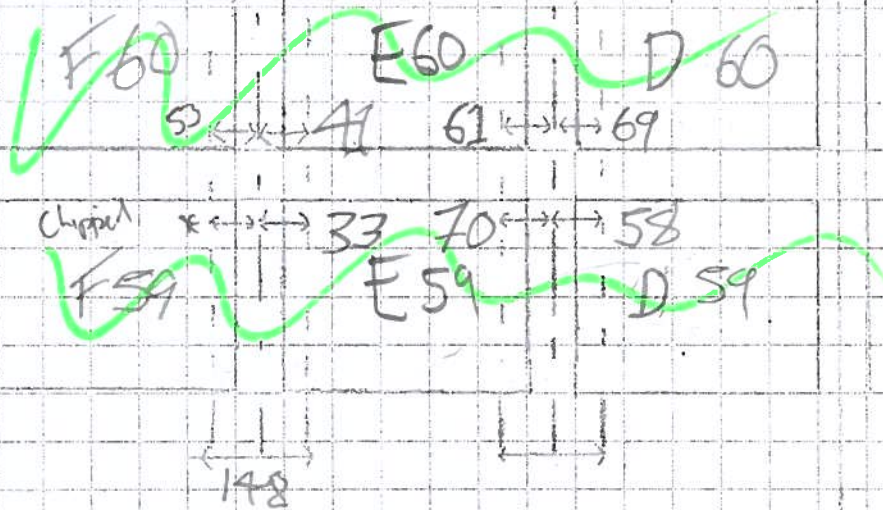

Location:

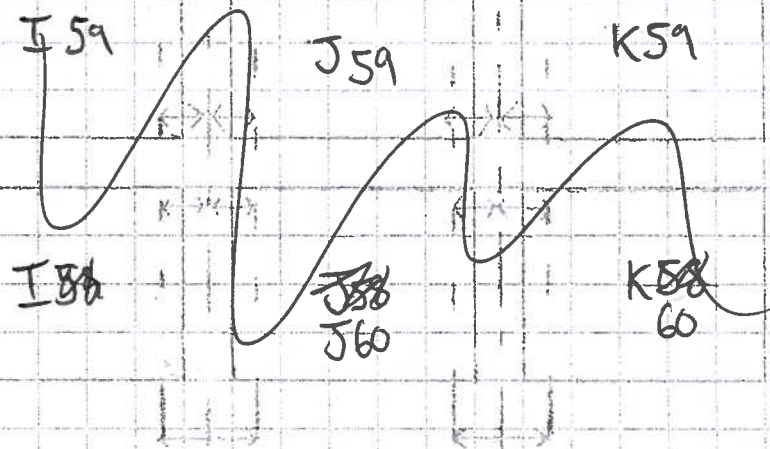

TEAM T5
28/9

Location: JS9



Location: F63

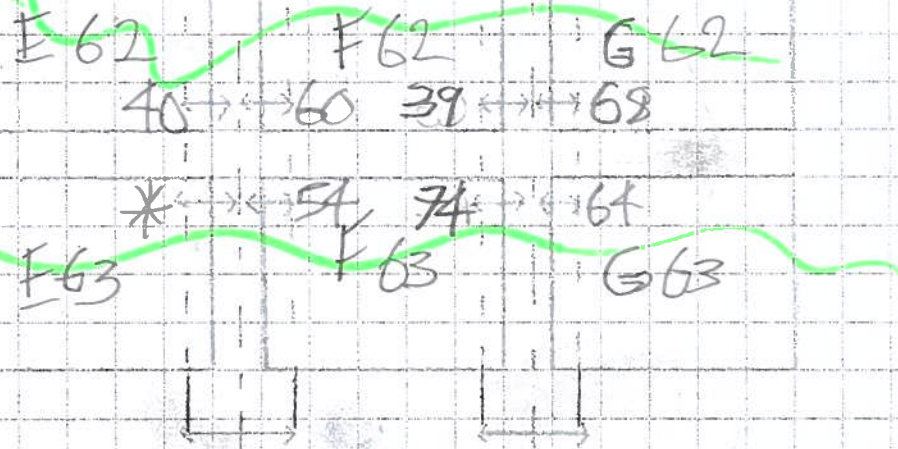

Location: D 71+72, E 71+72, F 71+72

Location: G 71+72, H 71+72, I 71+72

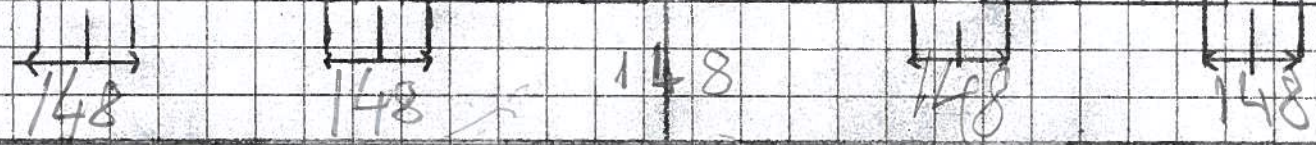
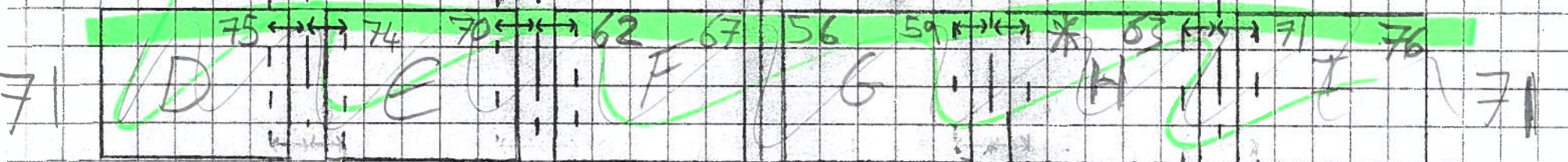

Location: E 77+78, F 77+78, G 77+78

Location: J 71+72

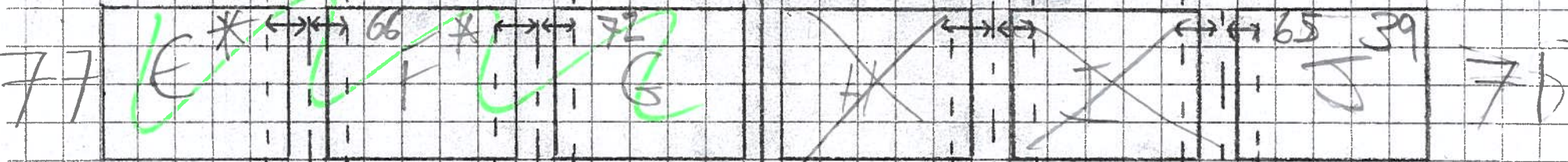
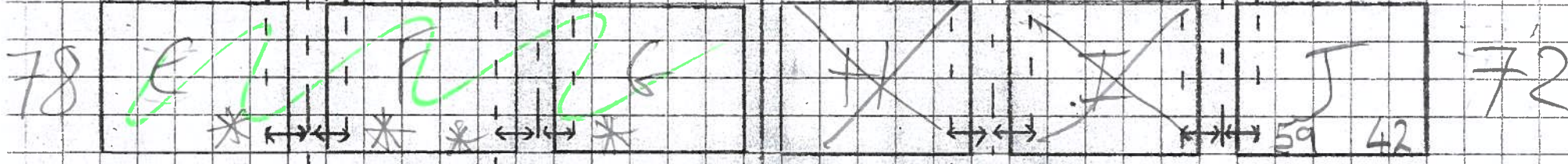

Location: H 75+76, I 75+76, J 75+76 Location:

76

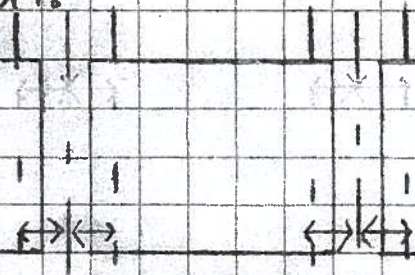
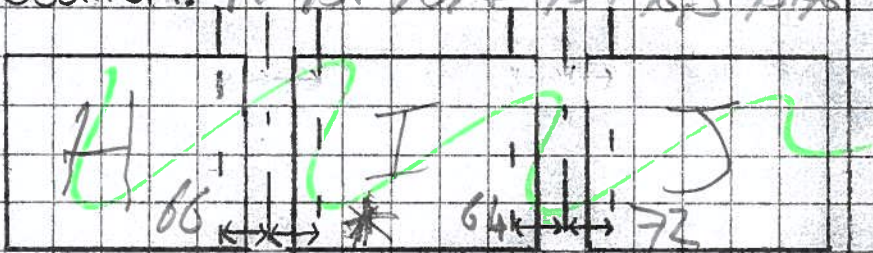

75

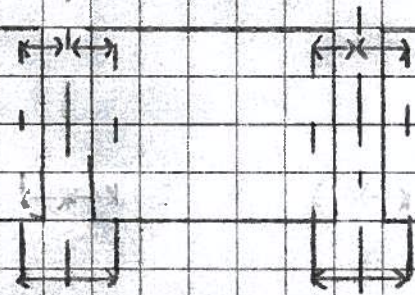
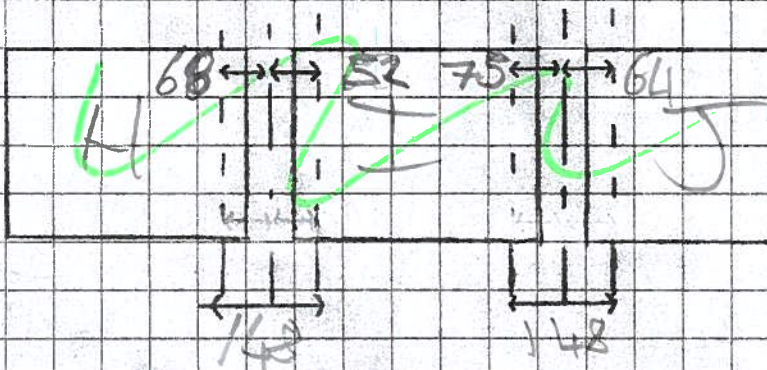

Location:

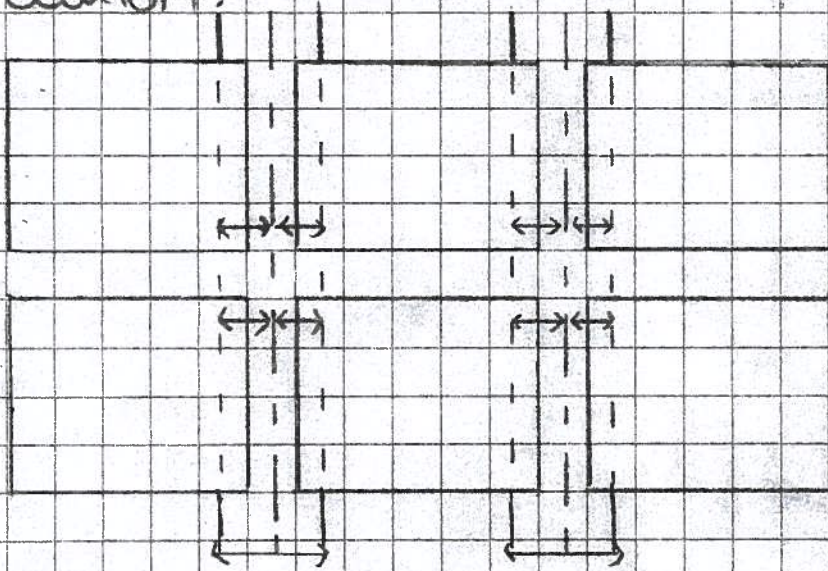

Location:

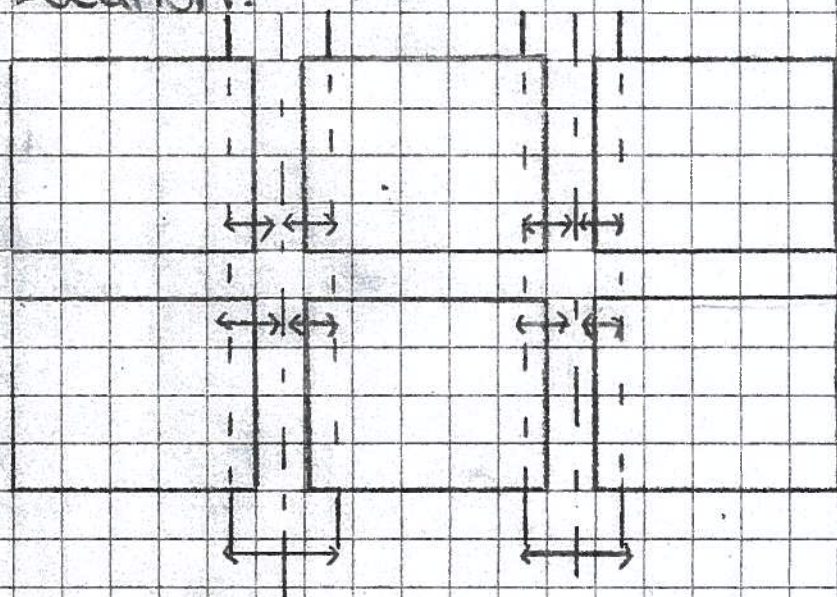

Location: $\angle Z_3 + Z_4, M Z_3 + Z_4$

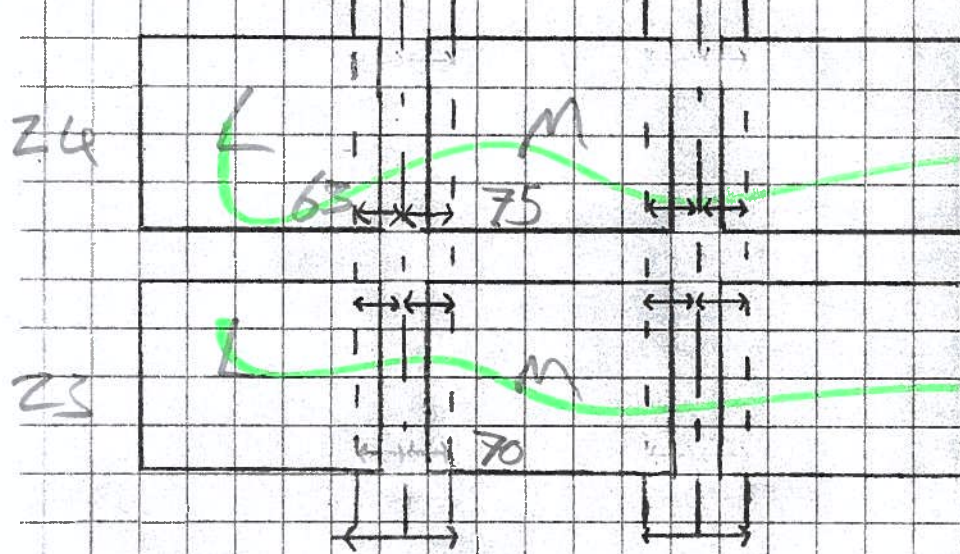

Location: $\angle Z_5 + Z_6, M Z_5 + Z_6$

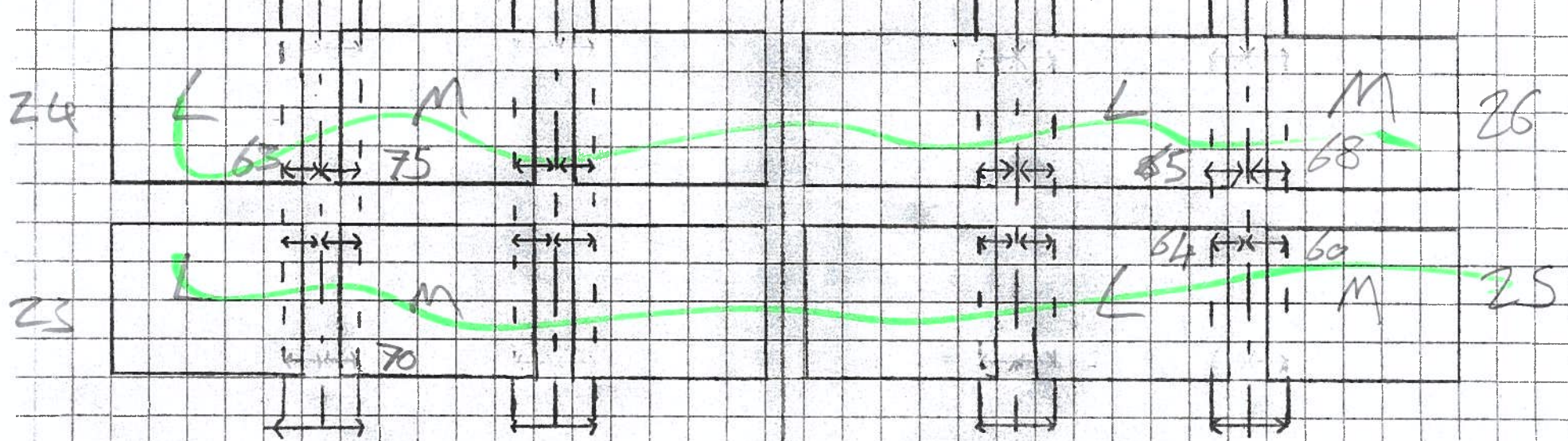

Location: $\angle 16 + 17, K 16 + 17$

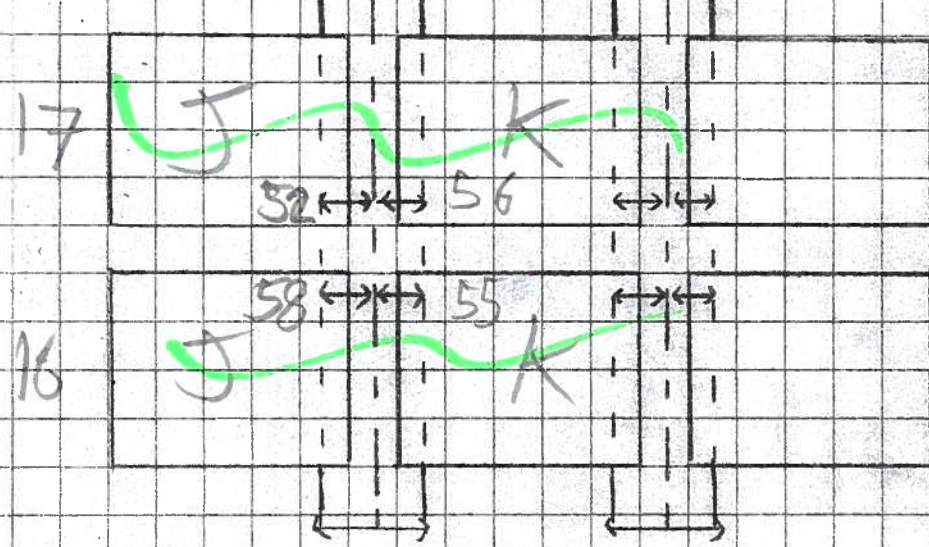

Location:

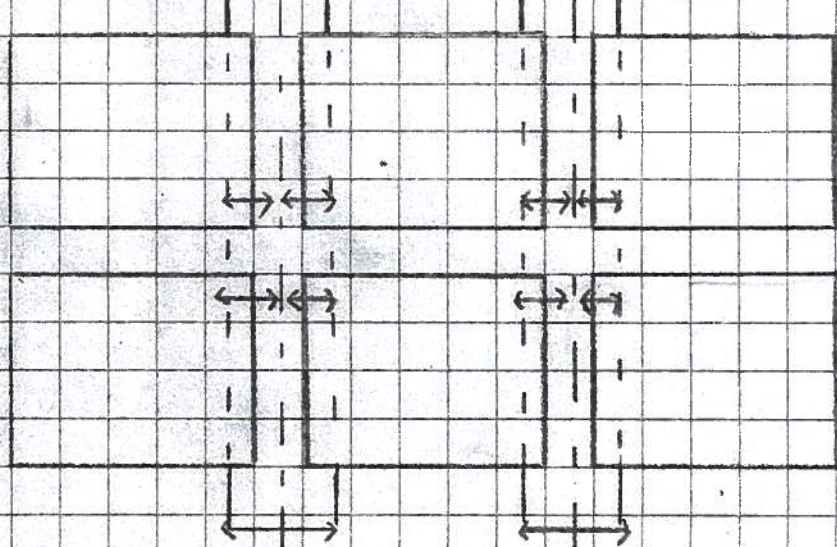

Location: K 17+16, L 17+16

Location: K 15

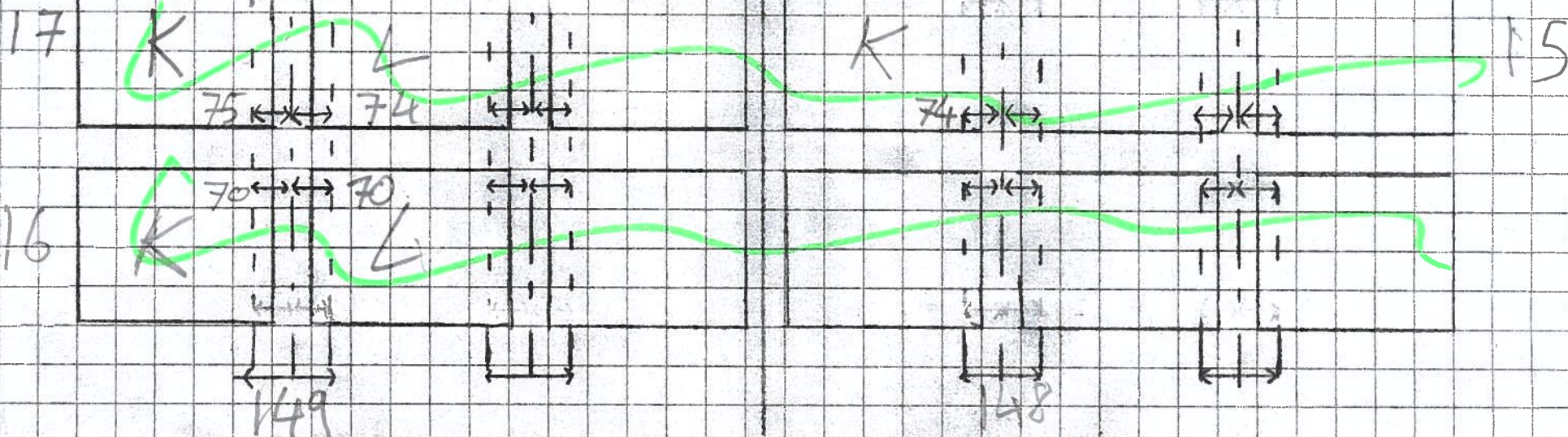

Location: J 21+22, K 21+22

Location: L 20+21, M 20+21

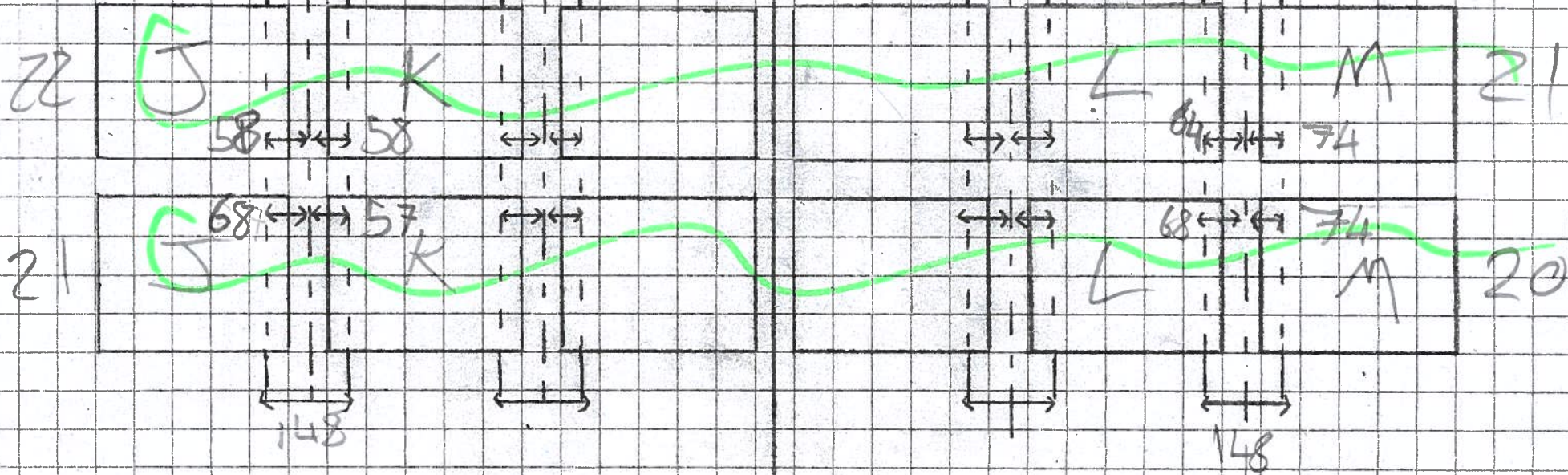

Location: C20+21, D20+21

21

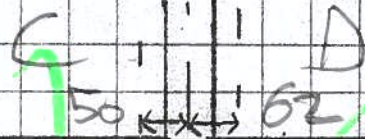

20

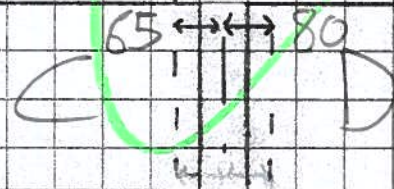

Location: B22+23, C22+23

23

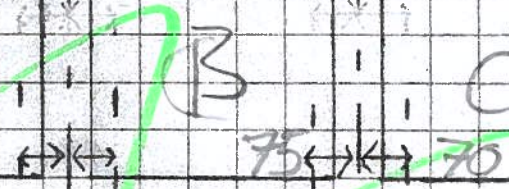

22

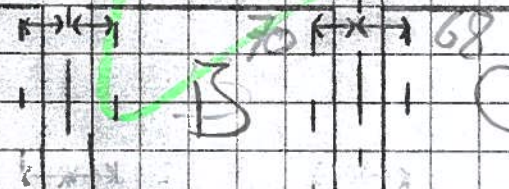

Location: F23+24, G23+24

24

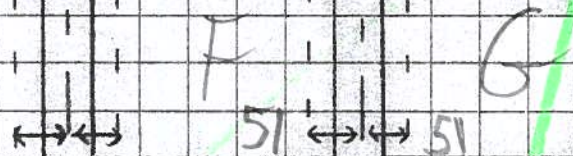

23

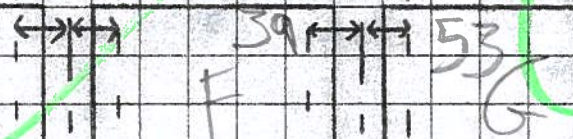

Location: B25+26, C25+26

26

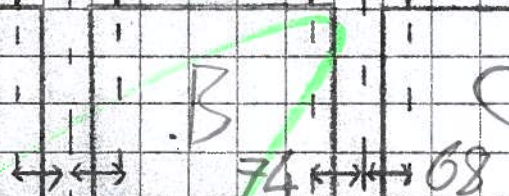

25

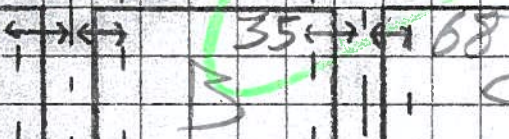

Location: B_{30+31}, C_{30+31}

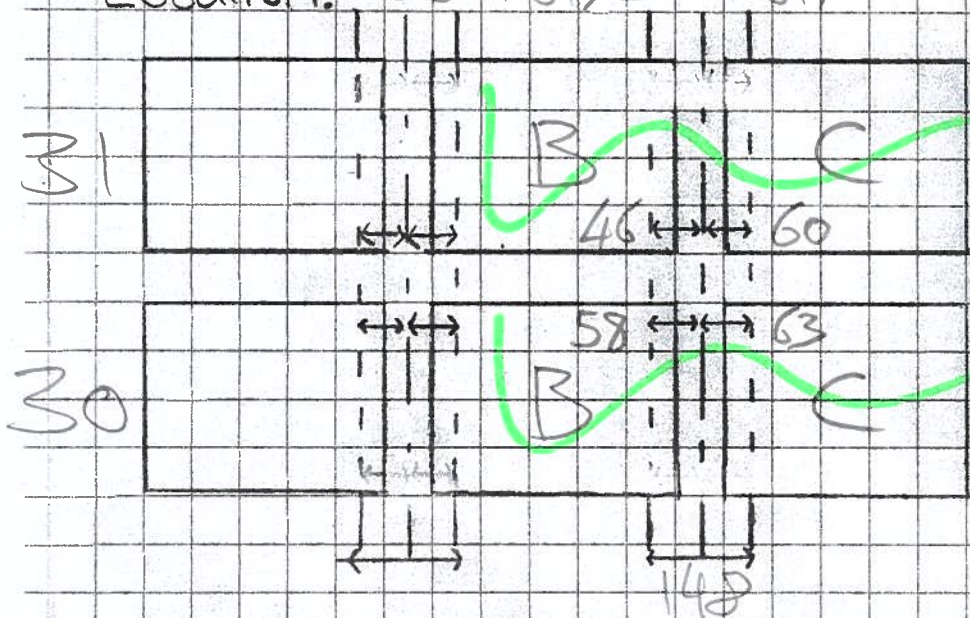

Location: B_{32+33}, C_{32+33}

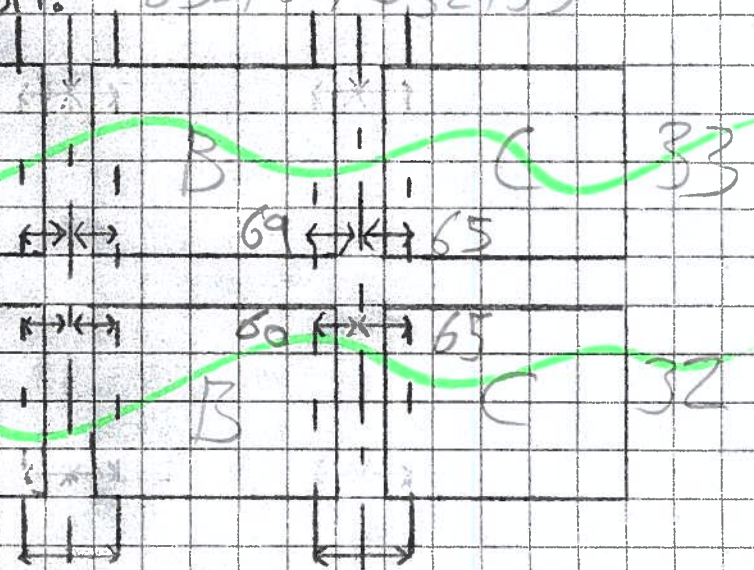

Location: F_{20+21}, G_{20+21}

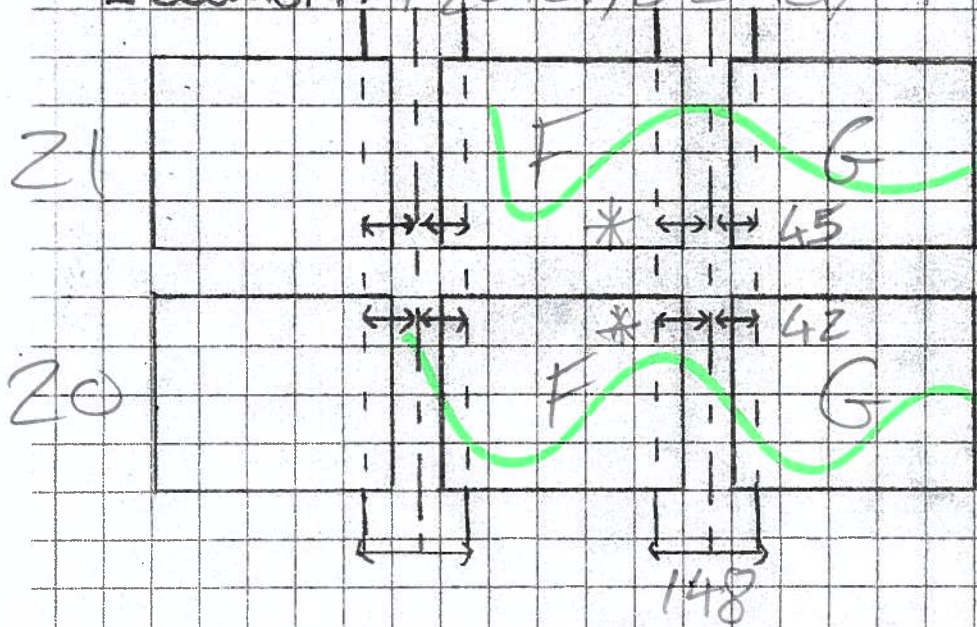

Location:

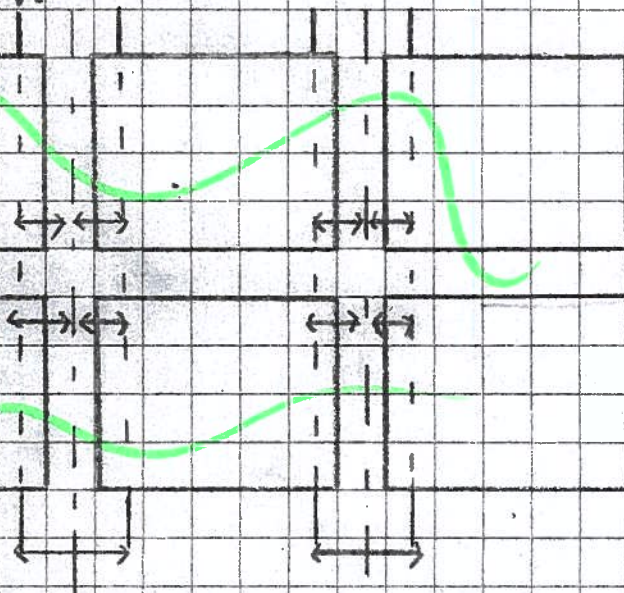

Rappel - End Bearing Survey results

	A	B	C	D	E	F	G	H	I	J	K	L	M	N
1														
2				64 68	75 70	* *	62 56	37 84	48 49					
3				66 69	78 75	52 *	66 65	30 80	55 66					
4														
5														
6														
7														
8										46	57			
9			**	71 74	30 *	* 50	68 63	73 44	43	41				
10			**	50 75	47 *	* 50	78 70	69 54						
11														
12														
13														
14														
15														
16										52 56	70 70			
17										58 55	75	74		
18				73	* 66	42 62	77 65	56 89	67 75	59 74				
19				* 41	60 62	67 54	59 77	65 54	75 73	55 77				
20		70 68	65 80				42							
21		75 70	50 62				45			68 57		68 74		
22		74 68								68 57		68 74		
23		35 68					39 53					64 60		
24							51 51			63 75				
25													65 60	
26				60	71					72	*		65 68	
27		85 64	75	*	69 *	44 75	66 55	59 65	25 49	58 53	77 58	68 72		
28		83 63	77 70	63 62	40 68		51 54	68	78 54	76 38	79 68	70 31		
29														
30		58 63												
31		46 60		62 61	44 56	72 65	67 57	75 41	74 42					
32				46 40	44 65	65 70	68 69	* 60	77 55					
33														
34														
35														
36		66 49	79 56		59 50	65 63	55 54	62 *		56 64	75 67			
37		54 60	76 55		57 72	55 81	56 64	36 *		51 69	76 58			
38														
39														
40														
41														
42														
43														
44														
45	82 53	71 63	72 76	84 49	67	51 55	71 *	83 52	53 72	44 78		33 42	53 40	
46	38 61	75 58	62 73	70 59	72 69	61 59	86 *	67 79	62 54	92 42		38 60	56 57	
47														
48														
49	53 51	50 *	67 66											
50	77	35 *	59 50											
51				58 75	66 82		44 70	* 73						
52				63 68	64 80		47 71	66 45	66 63	56 *	39 65	69 74	36 25	
53								81 40	70 61	59 *	60 69	69 44	49 26	
54														
55														
56														
57														
58												37	83 42	37 *
59										75 52	* *			37
60							65	68 *	73 *	55 63	*			
61														
62					40 60	39 68								
63				78 63	74 55	71 74	63 64	* 58	58 50	56 66	61 66	*		
64				77 56	75 68	39 67	68 50	* 53	84 65	72 38	68 72	*		
65														
66														
67												36	69 66	36
68				66	71					66	64			
69														
70														
71				64	75 74	70 62	67 56	59 *	63 71	76	64	46		
72					82 57	69 59	50 62	61 68	52 72	80				
73														
74														
75									68 52	75 64				
76									66 *	64 72				
77									59	42				
78									65	39				
79							81	62 67	71					
80														
81														
82														

Please note:
 All end bearing values displayed on the adjacent table are measured in millimetres (mm).
 Table adjacent displays end bearing measurements in format as received by Rappel. For visual purposes, this data has been orientated to reflect the main key plan in the written report.

Analysis of results		
Measurement	Value	Unit
Maximum end bearing	92	mm
Minimum end bearing	25	mm
Overall average end bearing	61.64082687	mm

Planks surveyed for end bearing



Rappel - End Bearing Survey results

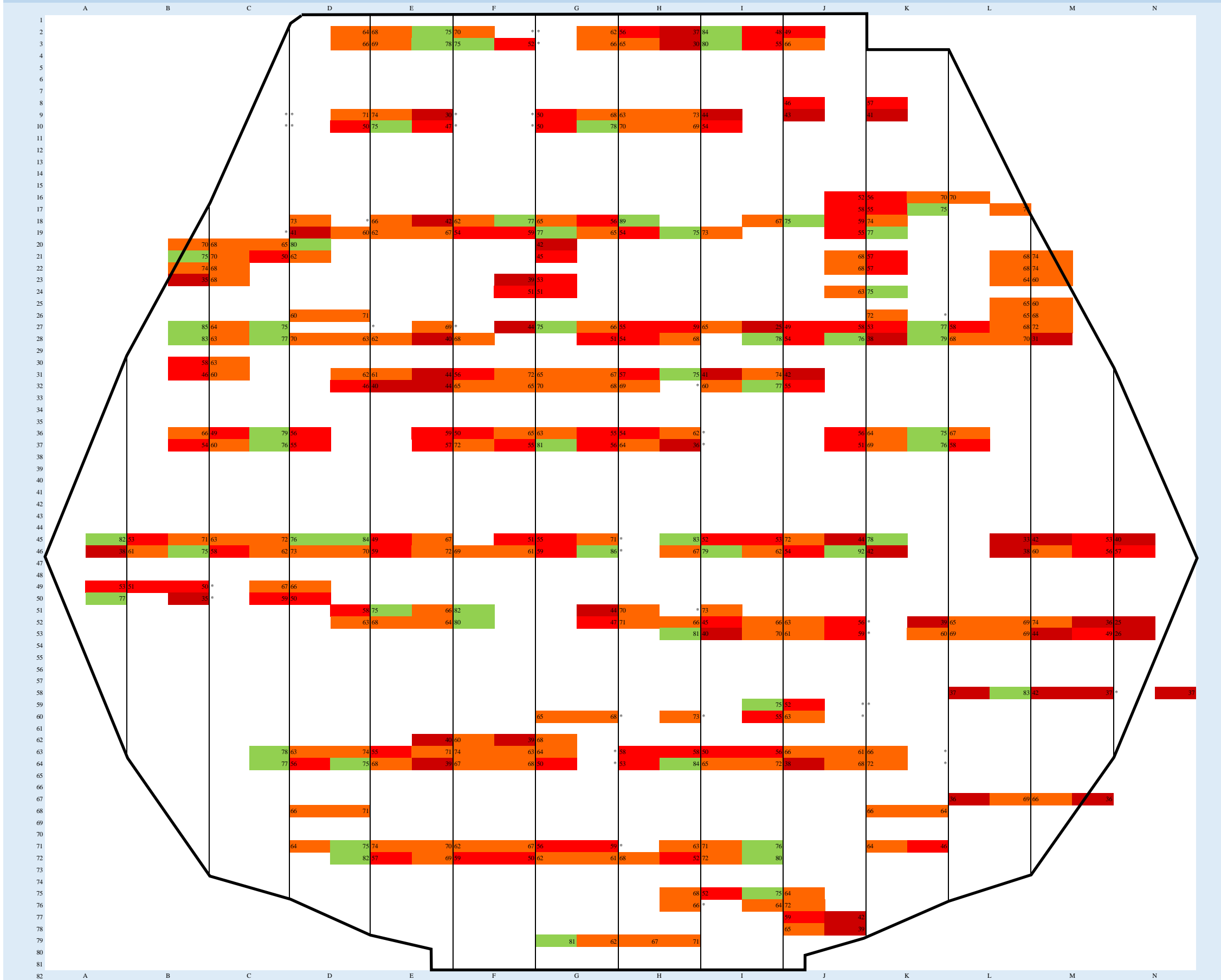

Appendix B

**RAPPEL SURVEY DATA – INTRUSIVE SITE
INVESTIGATIONS**



Location: -G60

Measurement = mm

Gmm Referral

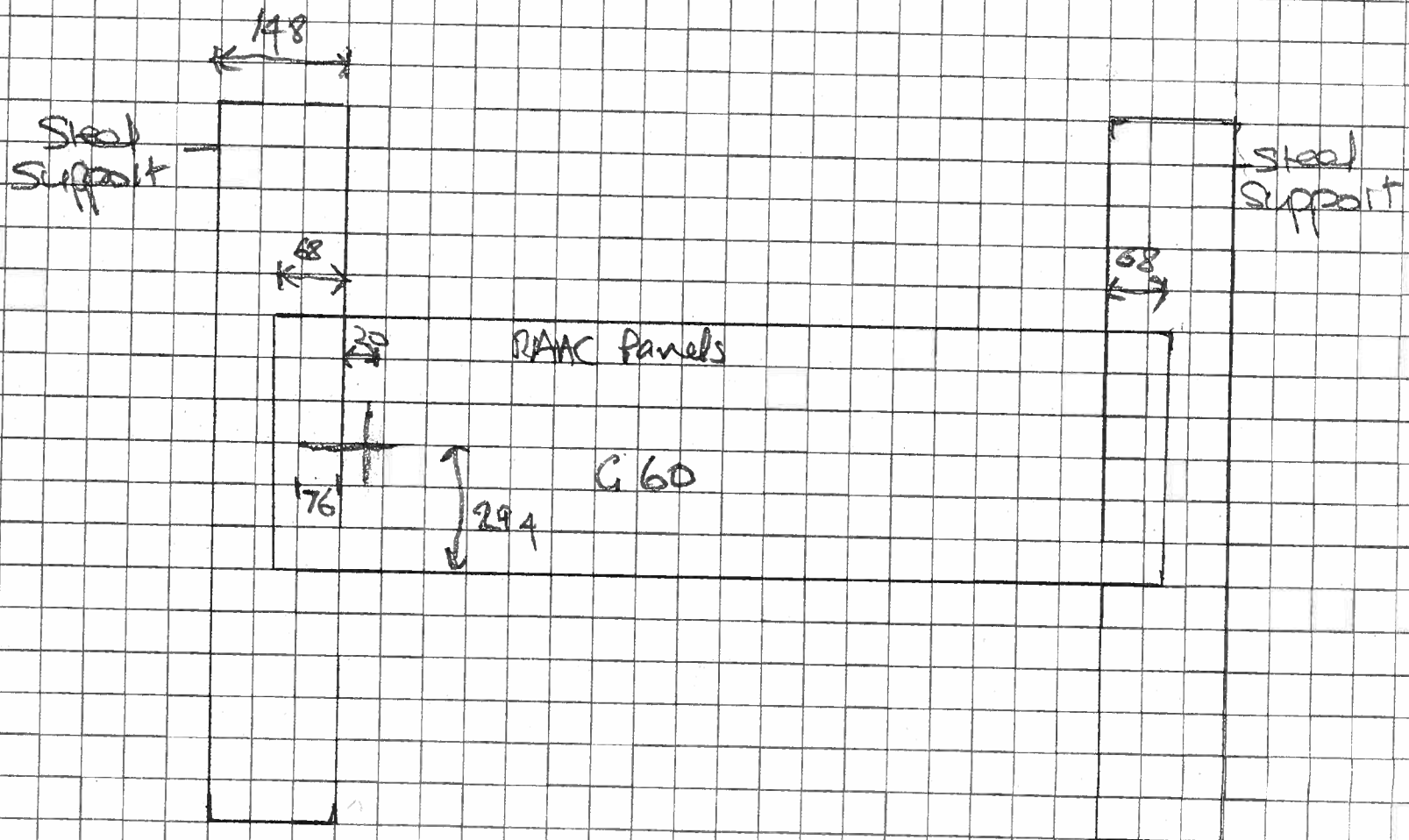

Intrusive investigation - G60

Location - D68

5-6 mm rebar

Measurements = MM

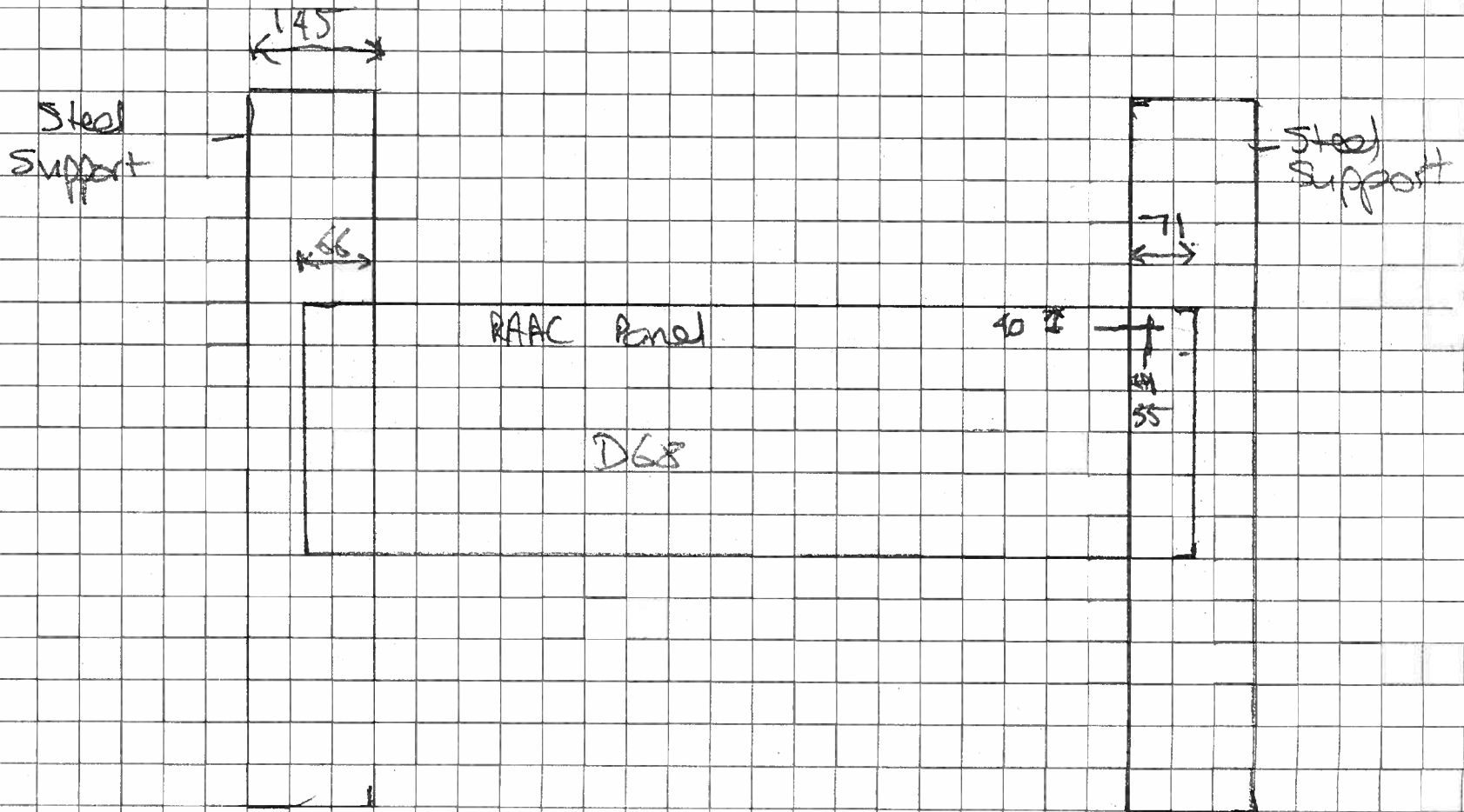

Intrusive investigation - D68

Location: - K 68

Ground level

MEASUREMENTS - mm

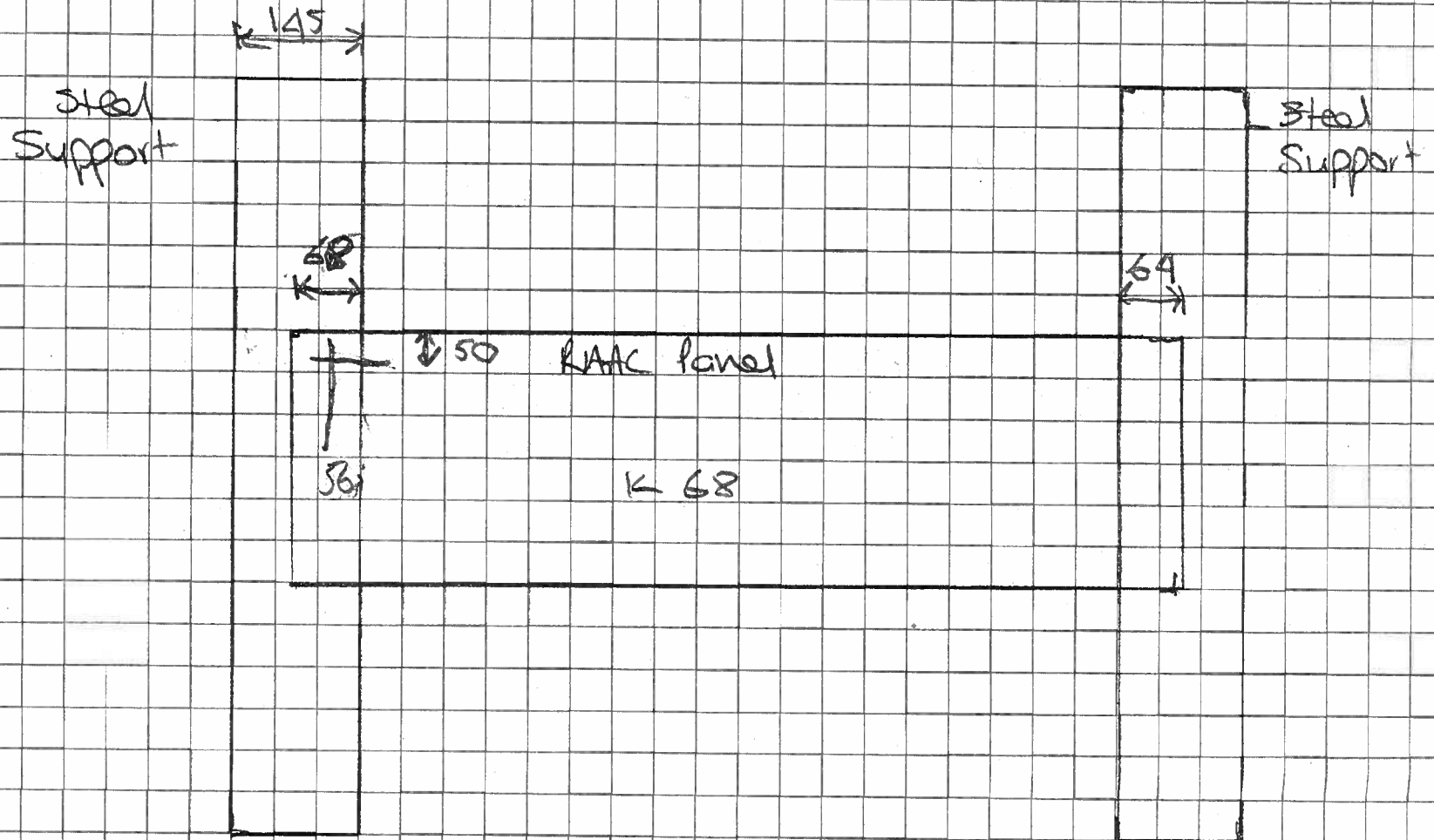

Location - K71

6 mm rebar?

Measurements = mm

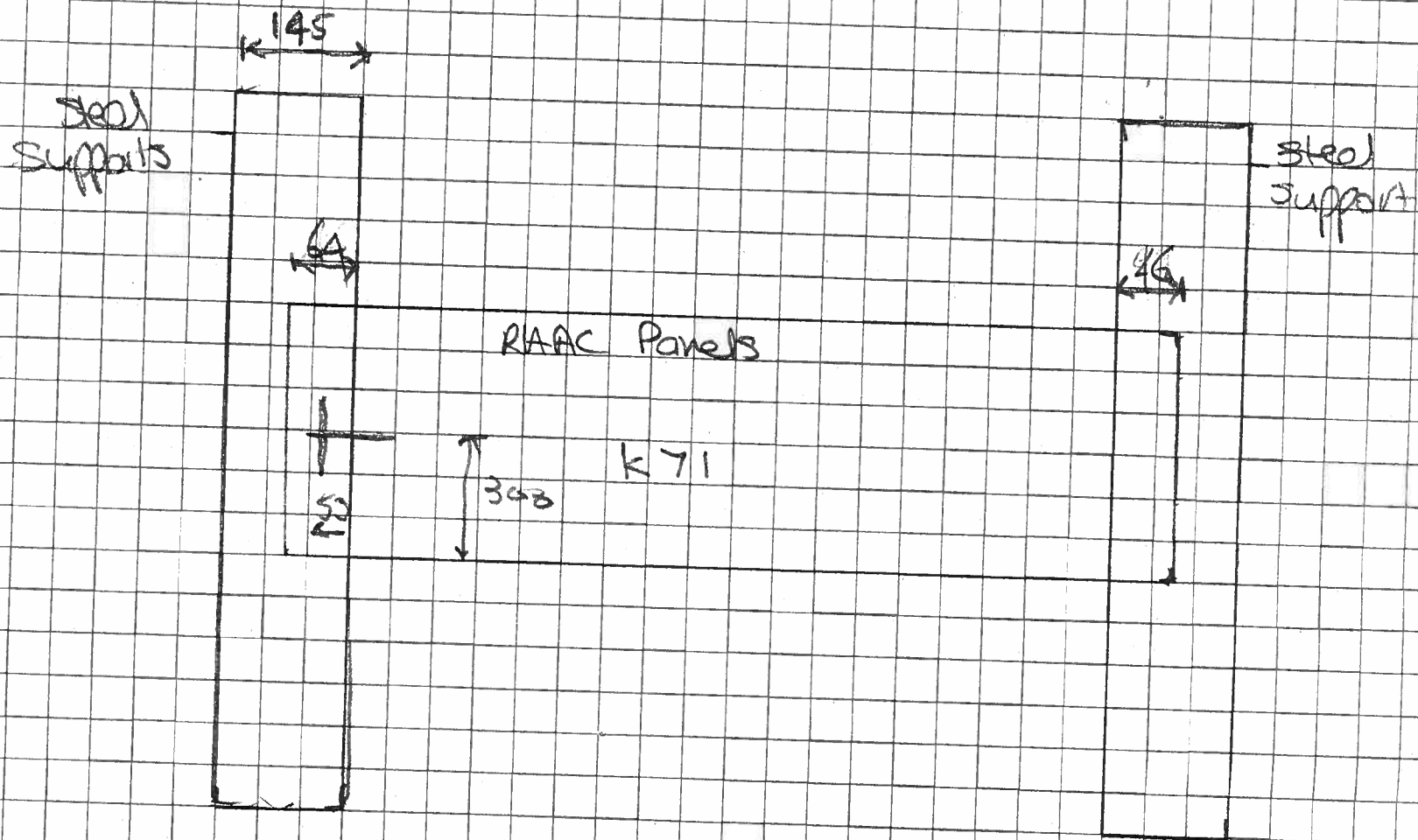

Intrusive investigation - K71

Location: - K26

Measurements = mm

6 mm rebar

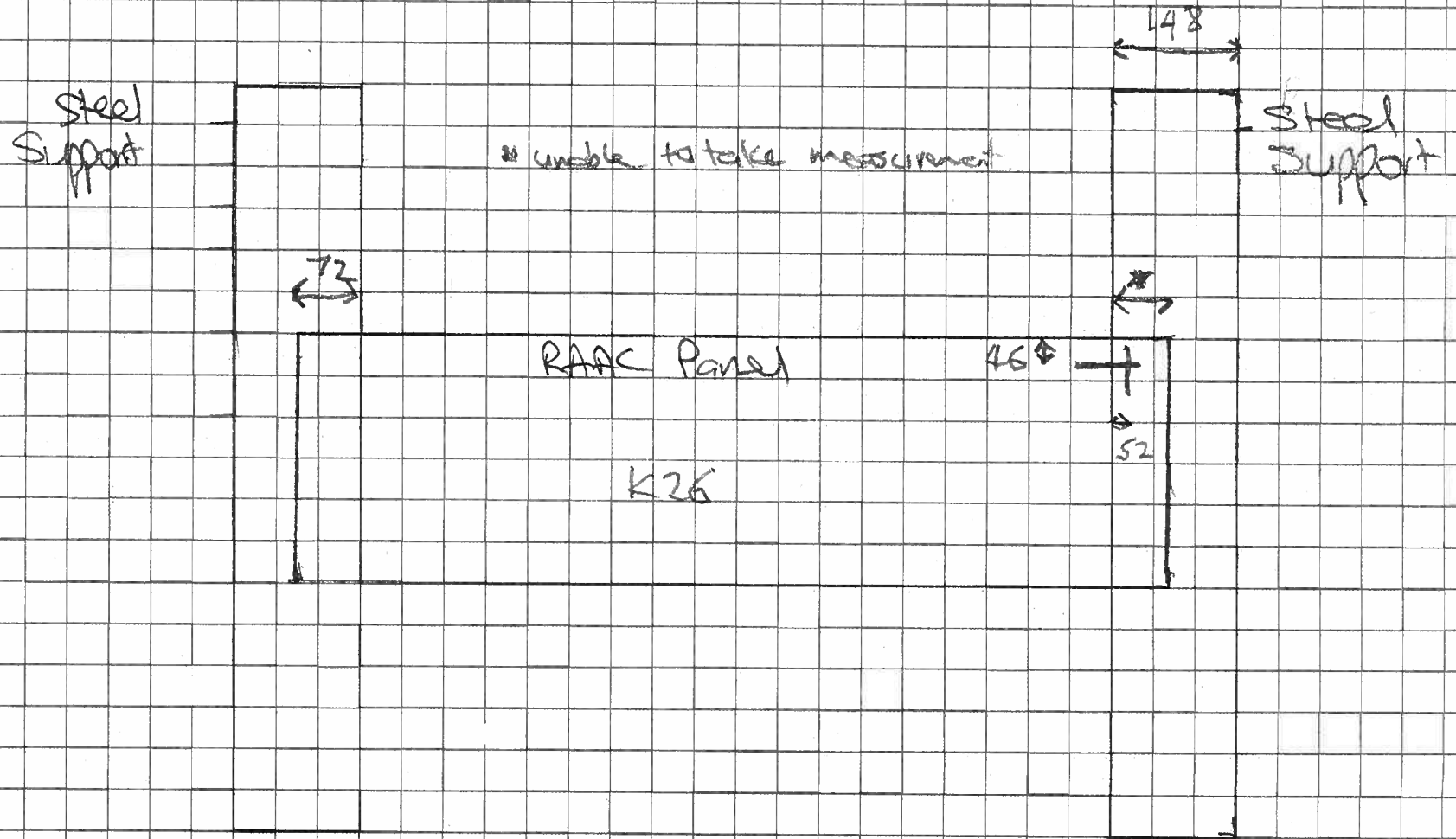

Location: - D26

measurements = mm

6 mm rebar

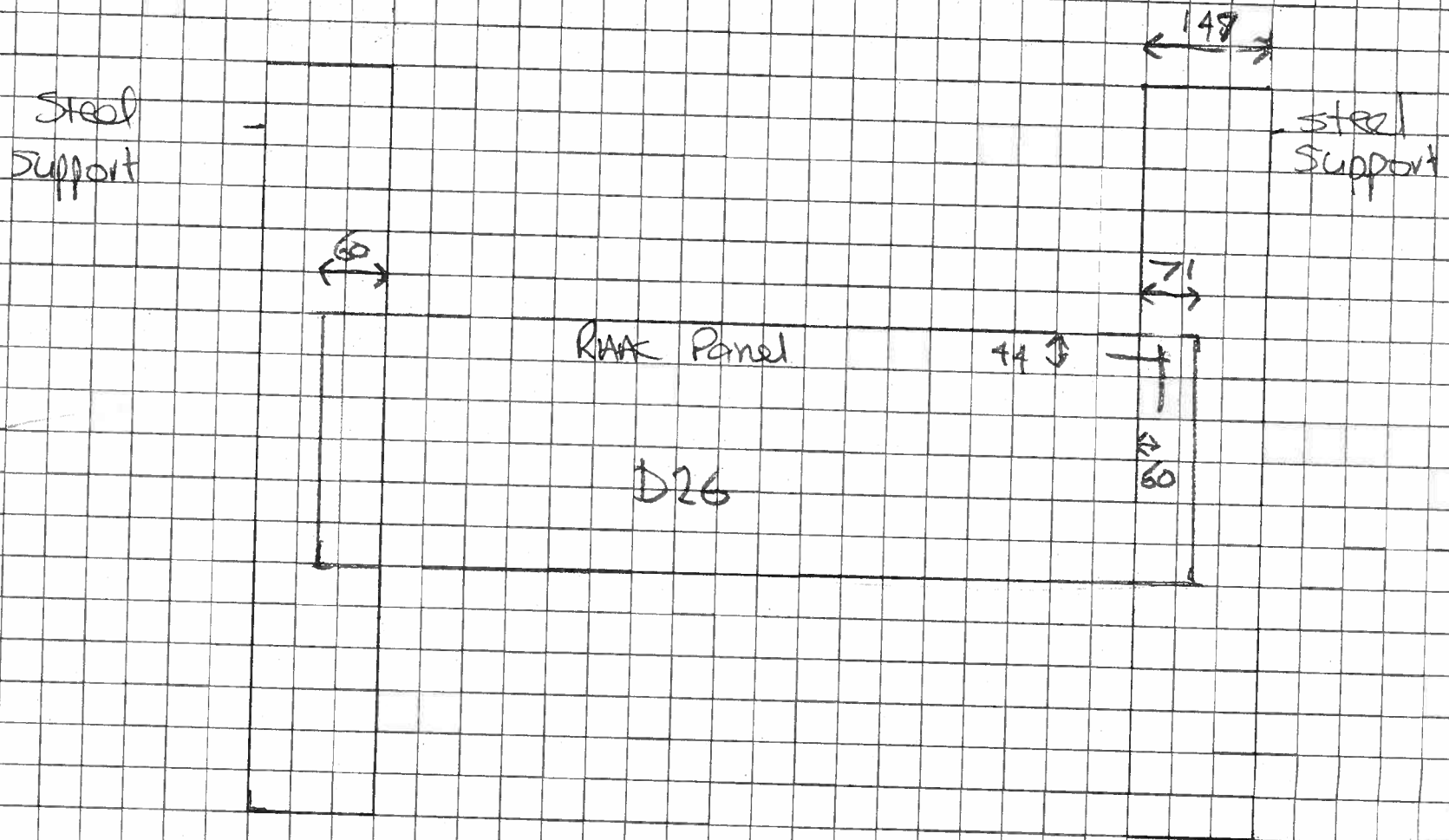

Intrusive investigation - D26

Location - D71

Gum Rehab

Measurements = MM

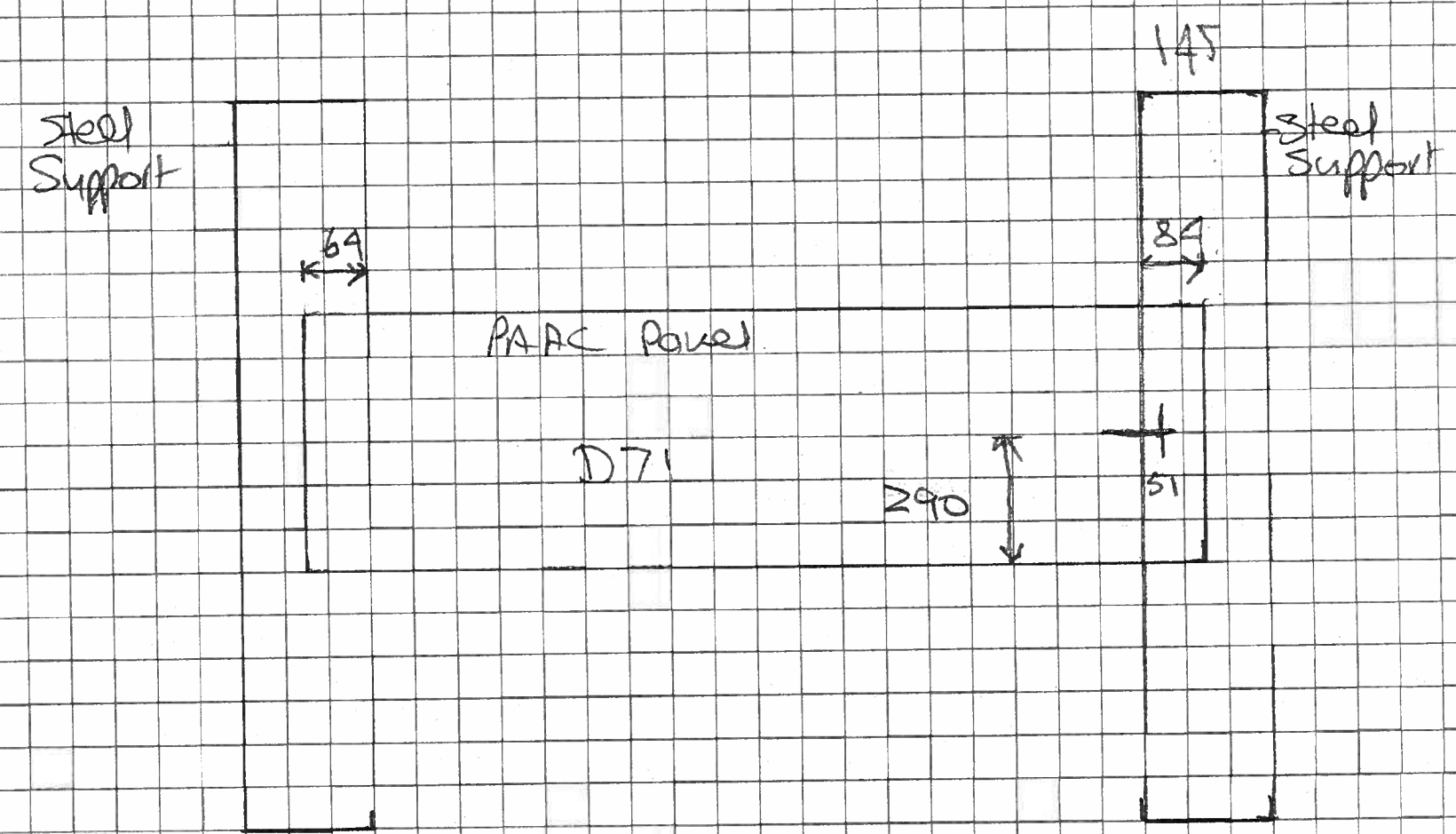

Intrusive investigation - D71

Location = H79

Measurements = mm

6mm rebar

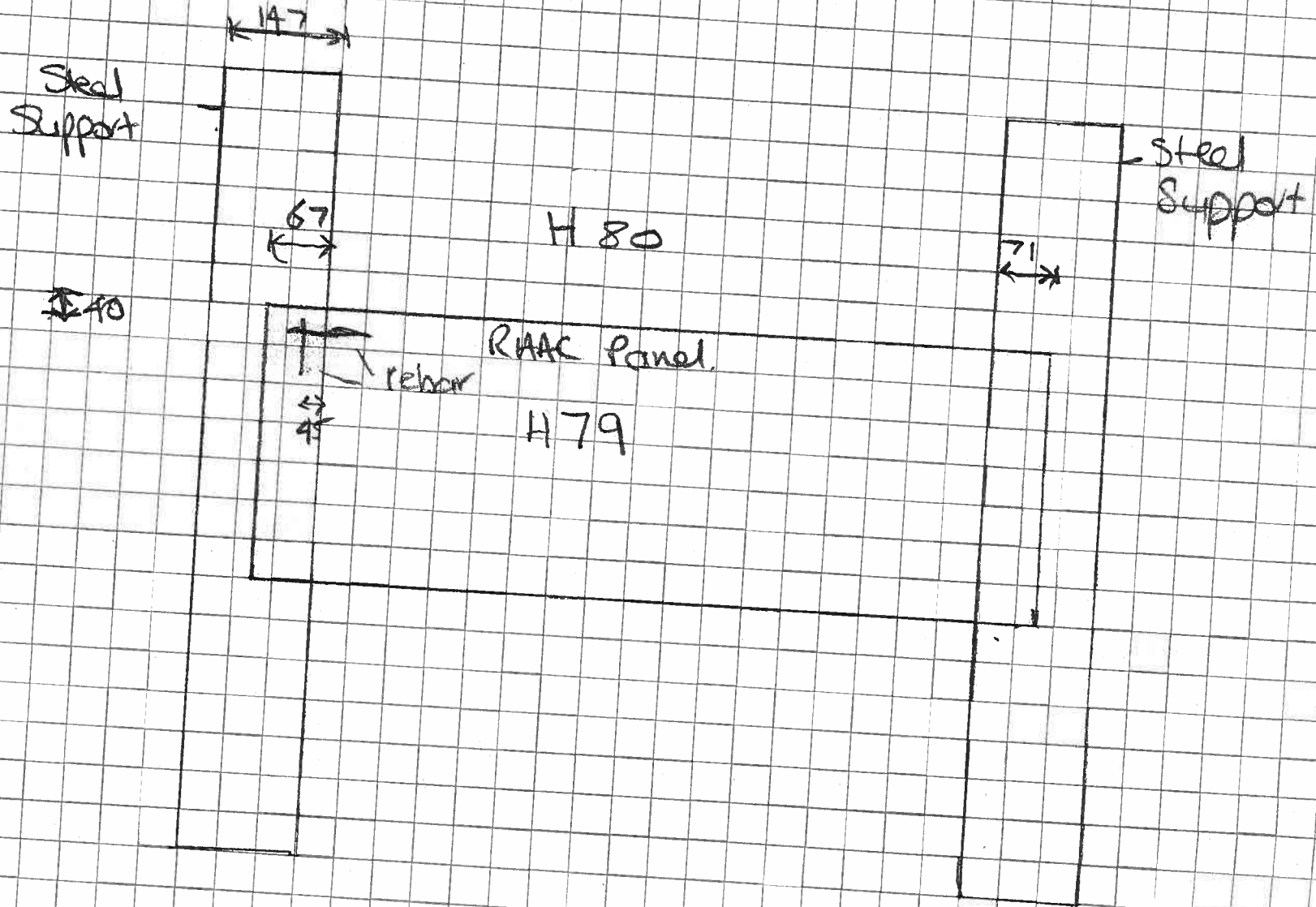

Intrusive investigation - H79

Location - H60

6mm repair

Measurement = mm

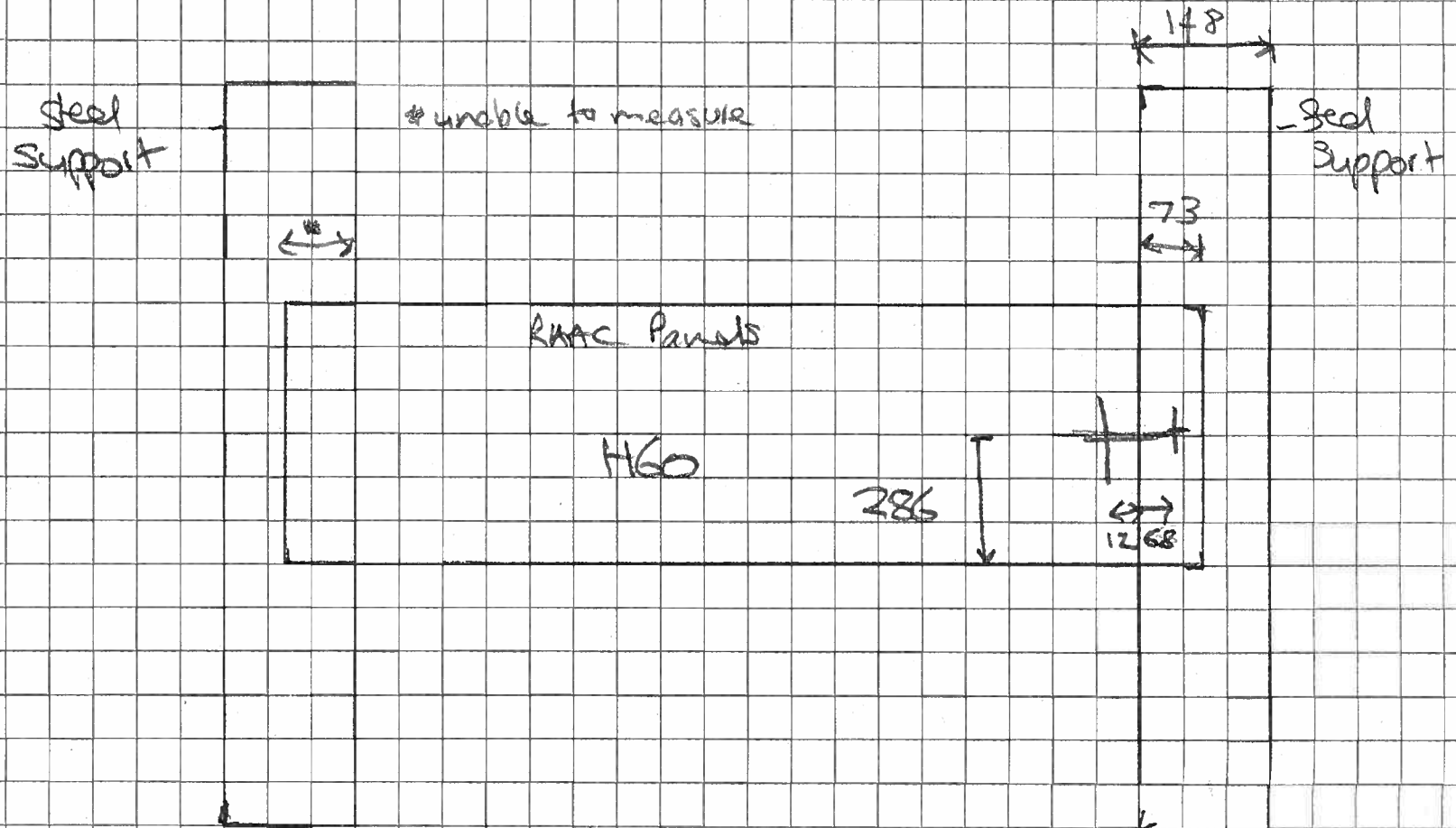

Intrusive investigation - H60



1 Capital Quarter
Tyndall Street
Cardiff
CF10 4BZ

wsp.com